

You can purchase this part at: <http://thmotorsports.com>

TRUST SUPER TUNING SYSTEMS AIMED AT REAL COMPETITORS.



TRUST

More installation manuals at: www.thmotorsports.net

Table of Contents

1.	Rebic IV Special Features	P1
2.	Parts List	P2 ~ P3
3.	Installation	P4 ~ P16
3-1	Wire and Vacuum Line Diagram	P6
3-2	Injector Driver Installation	P7 ~ P10
3-3	Pressure Sensor Installation	P11~ P12
3-4	Wiring Procedure	P13~ P14
3-5	Controller Installation	P15
3-6	Final Installation Inspection	P16
4.	Operation Instruction	P17~ P43
4-1	Controller Function	P18~ P19
4-2	Programming Flow Chart	P20
4-3	How to read the digital display	P21
4-4	Initial Setting	P22~ P23
4-5	Injector Test	P24
4-6	Run Mode	P25~ P29
4-6-1	How to set the Run Mode display	P25
4-6-2	How to set the Warning	P26
4-6-3	Security Lock Function	P27
4-6-4	HOLD and PEAK HOLD Function	P28~ P29
4-7	SETTING Mode	P30~ P39
4-7-1	SETTING Mode Flow Chart	P32
4-7-2	SETTING Mode Description	P33
4-7-3	Setting Procedure	P34
4-7-4	Set Boost Mode 1	P35
4-7-5	Set Boost Mode 2	P36
4-7-6	Set RPM Mode 1	P37
4-7-7	Set RPM Mode 2	P38
4-7-8	Total Offset Function	P39
4-8	Simulation Mode	P40~ P42
4-8-1	How to Calculate the Fuel Injected	P42
4-9	Setting Reset	P43

1. Rebic IV Special Features

- ◆ This product is an additional injector controller, which works independently from the factory ECU, to meet the additional fuel requirements of any forced induction application.
- ◆ Rebic IV can control 1 to 8 injectors.
- ◆ Boost Pressure can be programmed from $-1.0 \sim 3.0$ kg/cm² in 0.1 kg/cm² increments.
- ◆ RPM can be programmed from 0~12000 rpm in 100 rpm increments.
- ◆ Rebic IV can be used on 2~8 cylinder engine.
- ◆ The injectors can be fired sequentially or simultaneously.
- ◆ Real-time boost pressure, rpm, or injector(s) duty cycle can be displayed with the peak hold and warning feature.
- ◆ The injector(s) duty cycle can be simulated without running the vehicle for "fine tuning" of the fuel map.

2. PARTS LIST

IMPORTANT

Make sure that the items listed are included. If there are items missing, please contact your GReddy authorized dealer immediately.

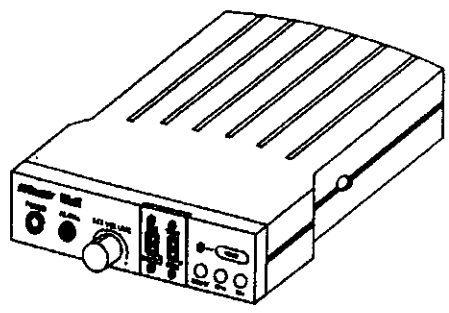

Rebic IV Controller X1

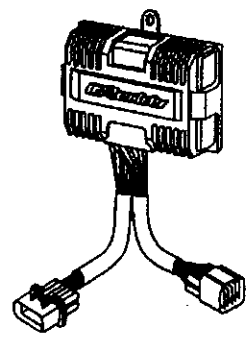

Injector Driver X1

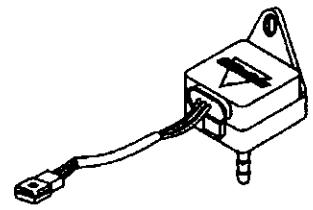

Pressure Sensor X1

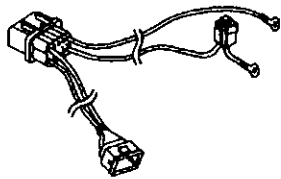

Injector Harness Assembly X1

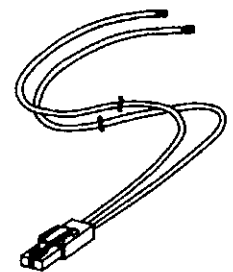

Power Harness 1m

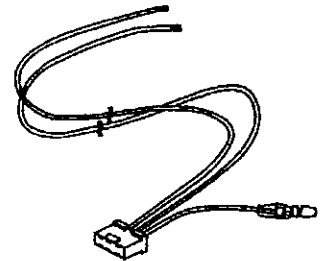

Signal Harness 1m

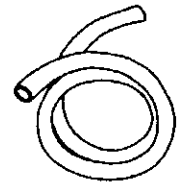



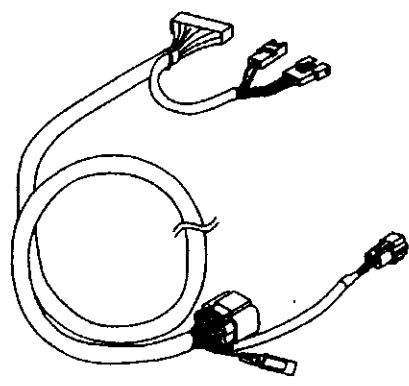

Vacuum Hose X1

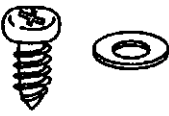
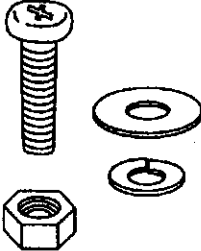
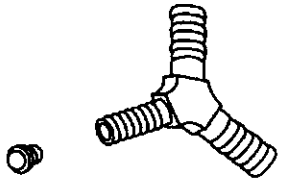

Main Harness X1

2. PARTS LIST

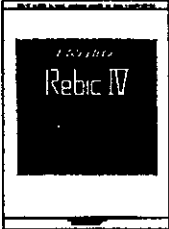
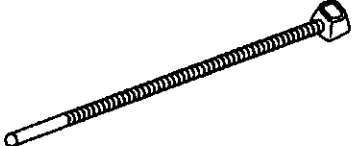
 Controller Mounting Hardware 2 sets	 M6 Bolt, nut, and washers 2 sets M6 Tapping screw 2	 Three-way Joint X1 Orifice X1
 Controller Mounting Bracket X1	 Controller Mounting Bracket Hardware X1	 Double Sided Tape 1 set
	 Instruction Manual X1	 Tie Wrap 15cm X10 20cm X5

REQUIRED TOOLS NEEDED FOR INSTALLATION

- Pliers
- Needle nose pliers
- +, - Screw Drivers
- 10mm Wrench
- Voltage Meter (12V Tester)
- Soldering Iron, and solder
- Electric Tape

3. Installation

Please read “**Precautions Before Installation**” thoroughly before starting the installation.

WARNING

- ⚠ **To avoid accidents, injuries, fire, or shorting-out the vehicles electronic components**, a trained technician who is familiar with the vehicle’s electric system should perform the electrical wiring.
- ⚠ Only install in a well-ventilated area free from any fire hazards. Working on the fuel system (the additional injector installation) near fire hazards can be **very dangerous**.
- ⚠ Make sure the engine has cooled down before installing this product. **Working on the vehicle while the engine is still hot can cause a fire or an injury.**

CAUTION

- Before installation, make sure that the vehicle’s key is out of the key cylinder, and the negative terminal is disconnected from the battery.
- Do not attempt to wire this product to the factory main injectors (injectors controlled by the factory ECU). This product is not designed to control the factory main injectors.
- Make sure that you have read and fully understood the wiring instruction and wiring diagram before working on the electrical system. Improper connections might damage the Rebic IV as well as the vehicle’s electric systems.

3. Installation

Cautions During Installation

- Make sure to use hose bands on all hoses. These should be installed to prevent them from being disconnected.
- If any wires were soldered together, use a shrink tube to avoid any electrical short.
- Be sure to mount the controller (head unit) inside of the vehicle away from moisture or excessive dust.
- Do not mount the controller in the area that is exposed to direct sunlight or near any heating vents.

Note to the Installer

- ✦ After the installation is complete, make sure that you hand this instruction manual to the customer.
- ✦ This instruction manual should be kept in the vehicle (to be used as reference during programming or troubleshooting).

3-1. Wire and Vacuum Line Diagram

For Injector Driver installation, see pages P7 ~ P10
For Pressure Sensor installation, see pages P11 ~ P12
For wiring instructions, see pages P13 ~ P14
For controller (head unit) installation, see pages P15

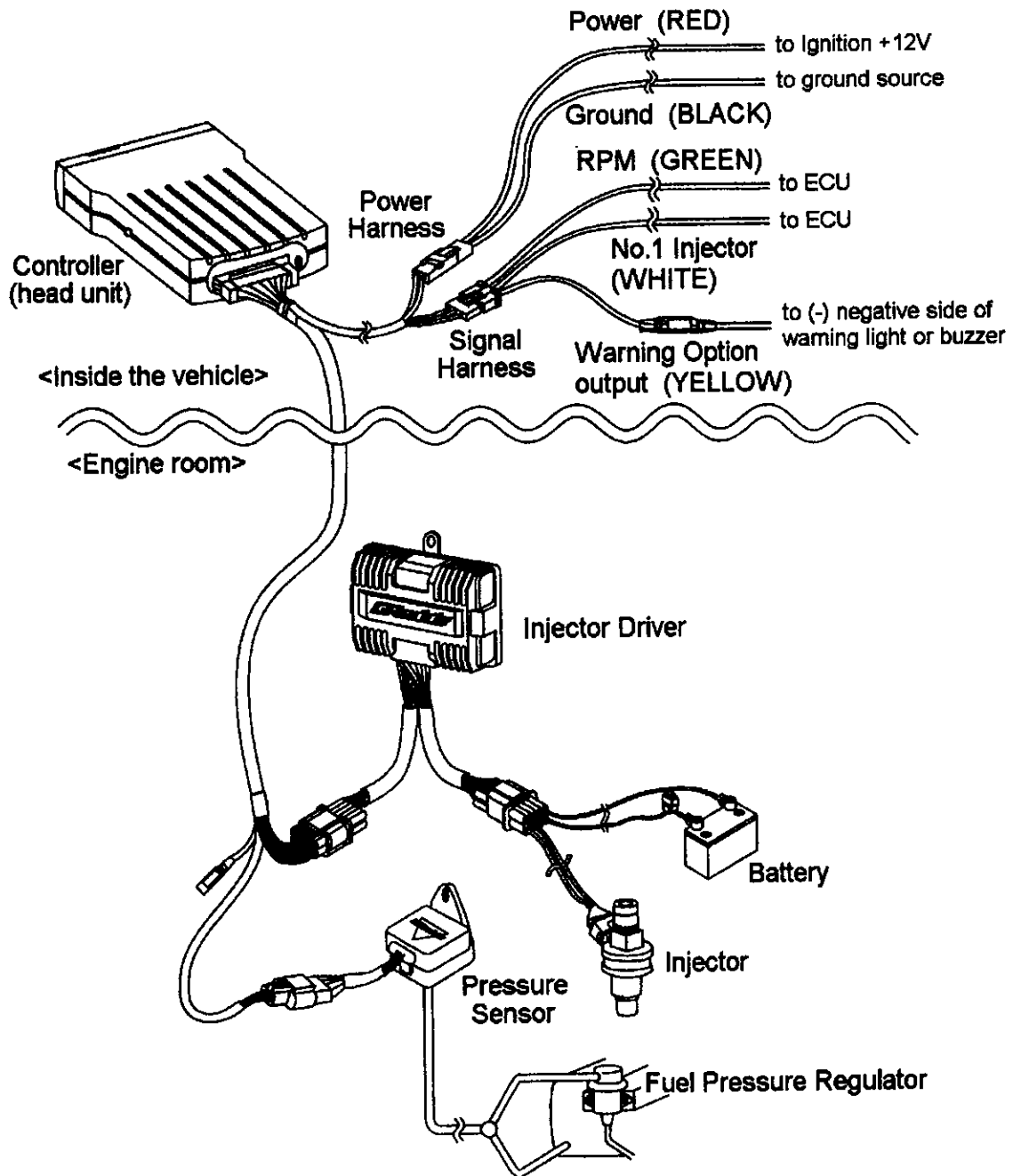

3-2. Injector Driver Installation

WARNING

- ⚠ Only install in a well-ventilated area free from any fire hazards. Working on the fuel system (the additional injector installation) near fire hazards can be **very dangerous**.
- ⚠ Make sure the engine has cooled down before installing this product. **Working on the vehicle while the engine is still hot can cause a fire or an injury.**

CAUTION

- The Injector Driver is not a repairable part. If the Injector Driver is damaged for any reason, a new replacement will have to be purchased, so read and follow the instruction carefully.
- Do not install the Injector Driver near the exhaust manifold, or any area exposed to excessive heat. Also, avoid any area exposed to water or moisture. Install it in a well-ventilated area.
- Avoid installing the Injector Driver, and Injector Driver Harness Assembly near any ignition system.
- To avoid any water or oil from entering the Injector Driver, mount the side with the wires facing down.
- Be sure that all connectors are securely locked with the sound of a "Click".
- Before installation, make sure that the vehicle's key is out of the key cylinder, and the negative terminal is disconnected from the battery.

3-2-1. Injector Driver Installation

Installation

- ① Check the length of the harness when looking for a mounting location. Make sure the harness is long enough, and route the wires neatly, so that they will not get entangled.
- ② Mount the Injector Driver so that the side with the wires facing down. (DO NOT bend the steel mounting bracket)

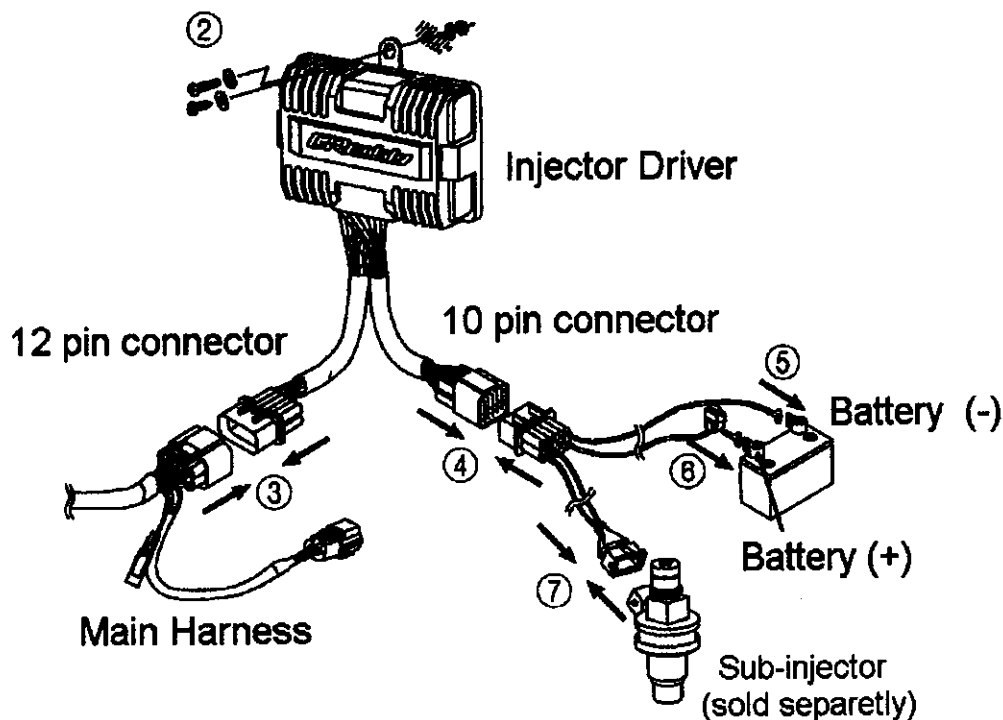

- ③ Connect the Main Harness 12 pin connector to the Injector Driver 12 pin connector. (see 4-2.3, before step ③)
- ④ Connect the Injector Harness Assembly 10 pin connector to the Injector Driver 10 Pin connector. (see 4-2.2, before step ④)
- ⑤ Connect the Ground wire (black) from the Injector harness assembly to the (-) negative terminal of the battery.
- ⑥ Connect the Power wire (red) from the Injector Harness assembly to the (+) negative terminal of the battery.
- ⑦ Connect the Injector harness to the sub-injector.

3-2-2 Injector Driver Installation

When using 2~4 Injectors

CAUTION

- Do not reverse the White and Red wire on the Injector Harness. This may cause engine damage.
- Leave the rubber caps in the terminals that are not being used on the Injector Harness connector.

IMPORTANT

- When sequential firing features for individual cylinder is used, make sure that 1~4 terminal on the 10 pin connector matches with the engine's firing order. Example: Terminal # ① ② ③ ④
(See figure below) Firing order 1 - 3 - 4 - 2

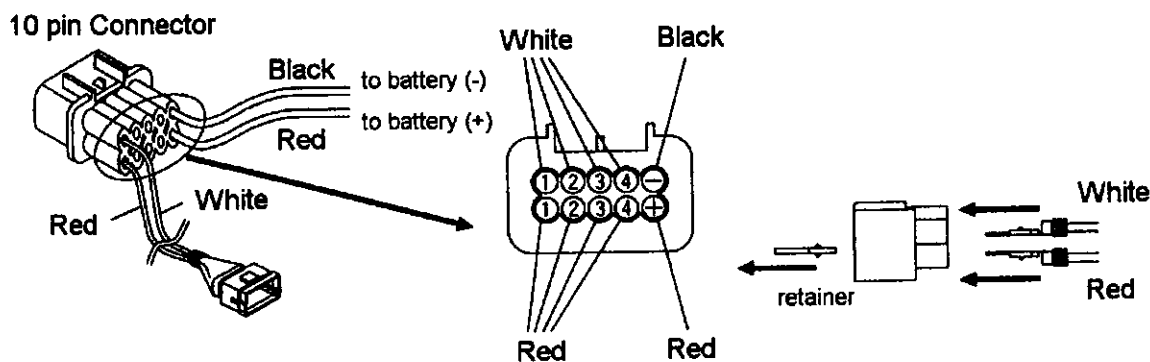

Wiring Procedure

When using 2~4 injectors, additional Injector Harnesses are necessary. (Sold separately - part # 15900001)

- ①. Remove the rubber caps from the terminal that are being used.
- ②. Remove the retainer out of the Injector Harness.
- ③. Insert the Injector Harness pins in to the Injector Harness Assembly connector.
*Make sure that the directions of the pins are correct.
- ④. Reinstall the retainer to the connector.

3-2-3 Injector Driver Installation

When using 5~8 Injectors

CAUTION

- Do not reverse the White and Red wire on the Injector Harness. This may cause engine damage.
- Leave the rubber caps in the terminals that are not being used on the Injector Harness connector.

IMPORTANT

- When sequential firing features for individual cylinder is used, make sure that 5~8 terminal on the 10 pin connector matches with the engine's firing order.

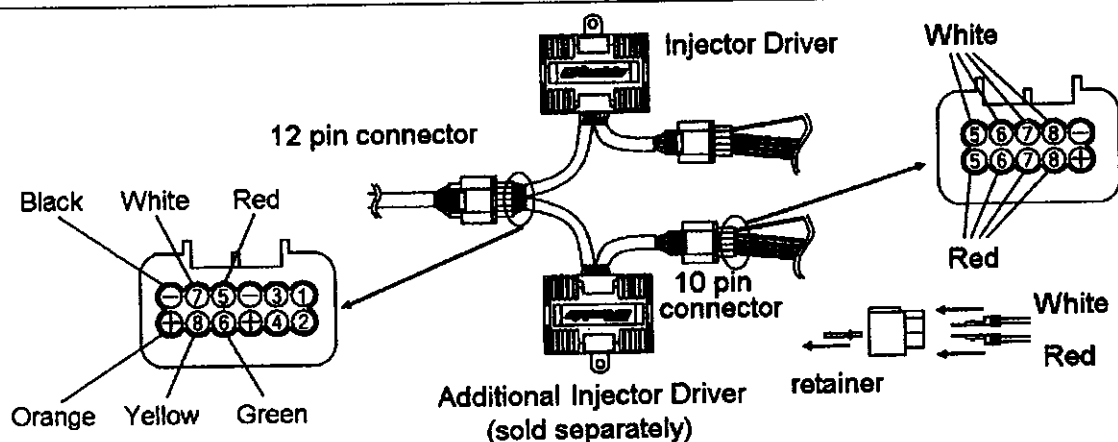

Wiring Procedure

- Follow the Injector Driver installation instructions on page 7~9.
 - When using 5~8 injectors, additional Injector Driver, Injector Harness assembly, and Injector Harnesses are necessary.
(Sold separately)
- ① Remove the retainer out of the Injector Driver 12 pin connector.
 - ② Insert the connector pins from the Additional Injector Driver to the 12 pin connector on the Injector Driver as shown above.
 - ③ Reinstall the retainer to the 12-pin connector.
 - ④ Remove the retainer out of the Injector Harness, and insert the Injector Harness pins in to the Injector Harness Assembly connector.
***Make sure that the directions of the pins are correct.**
 - ⑤ Reinstall the retainer to the connector.

3-3. Pressure Sensor Installation

WARNING

- ⚠ Make sure the engine has cooled down before installing this product. **Working on the vehicle while the engine is still hot can cause a fire or an injury.**

CAUTION

- The Pressure Sensor is not a repairable part. If Pressure Sensor is damaged for any reason, a new replacement will have to be purchased, so read and follow the instruction carefully.
- Do not install the Pressure Sensor near the exhaust manifold or any other area with excessive heat. Also, avoid any area exposed to water or moisture. Install it in a well-ventilated area.
- Avoid installing the Pressure Sensor near any ignition system.
- Be sure that all connectors are securely locked with the sound of a "Click".
- Before installation, make sure that the vehicle's key is out of the key cylinder, and the negative terminal is disconnected from the battery.

Important

- Check the length of the provided Vacuum Hose when looking for a mounting location. Make sure to mount the Pressure Sensor so that the provided Vacuum Hose is long enough, and route the hose clean in the engine room.

3-3. Pressure Sensor Installation

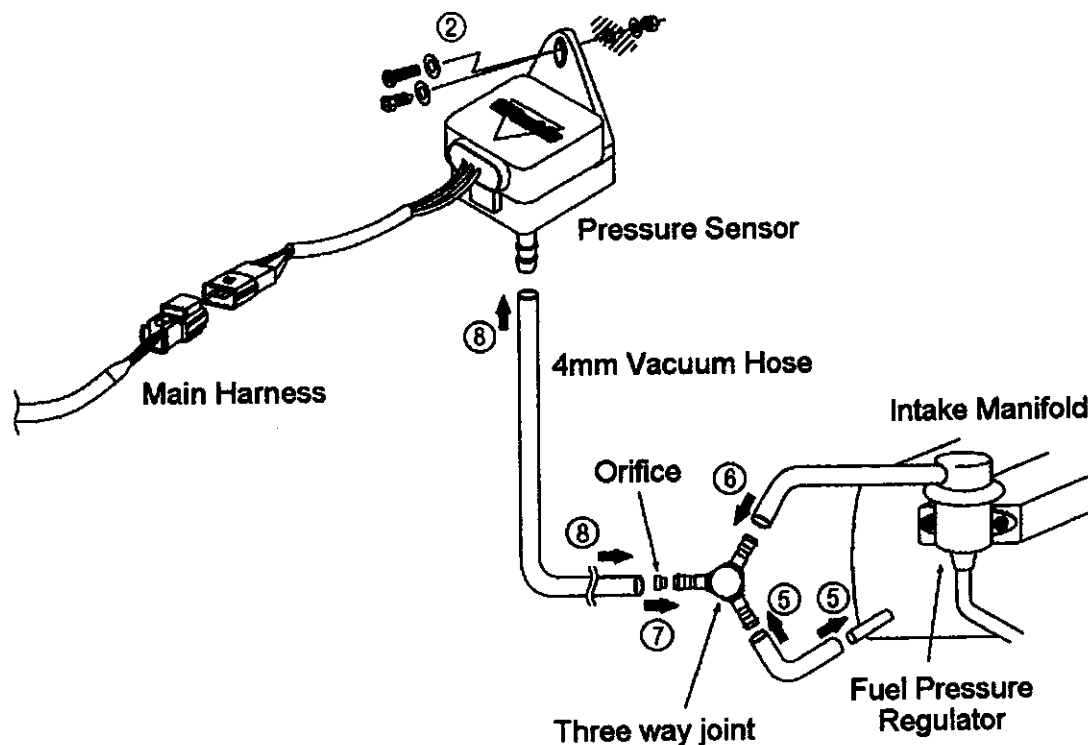

Installation and Vacuum Hose Routing

- ①. Check the length of the harness and the hose routing when looking for a mounting location. Make sure the harness and the hose is long enough.
- ②. Mount the Pressure Sensor with the vacuum nipple facing down.
- ③. Cut 2~3 inches off, from the provided Vacuum Hose.
- ④. Disconnect the vacuum hose from the intake manifold for the fuel pressure regulator.
- ⑤. By using the cut vacuum hose, install the Three-way Joint to the Intake manifold.
- ⑥. Connect the hose that was disconnected at ④ to the Three-way Joint.
- ⑦. Insert the Orifice into the Three-way Joint.
- ⑧. Connect the Vacuum Hose from Pressure Sensor to the Three-way Joint.
- ⑨. Connect the Pressure Sensor to the Main Harness 3 pin connector.

3-4. Wiring Procedure

WARNING

-  **To avoid accidents, injuries, fire, or shorting-out the vehicles electronic components, a trained technician who is familiar with the vehicle's electric system should perform the electrical wiring.**

CAUTION

- Before installation, make sure that the vehicle's key is out of the key cylinder, and the negative terminal is disconnected off from the battery.
- Be sure that all connectors are securely locked with the sound of a "Click".
- Make sure the RPM, and the Injector Signal wires are connected correctly. Incorrect wiring may cause engine, and ECU damage.
- Test the voltage with a tester, before wiring the power lead.

Important

- Make sure to solder and shrink-wrap the power (red) lead, to get a good power source and to avoid any electrical short.

Main Harness wiring procedure (Engine room side)

- ①. Route the Main Harness through an opening in the firewall. If there are no accessible opening, drill one and route the harness through into the vehicle. Make sure to use a rubber grommet on the opening to protect the harness.
- ②. Secure the harness with provided tie wraps.

3-4. Wiring Procedure

Power Harness wiring procedure

- ①. Using a voltage tester, locate a ignition +12V wire and solder the Power (red) wire to it.
- ②. Solder the Power Harness Ground (black) wire to the vehicle's ground wire.
- ③. Connect the Power Harness to the Main Harness 2 pin Connector.

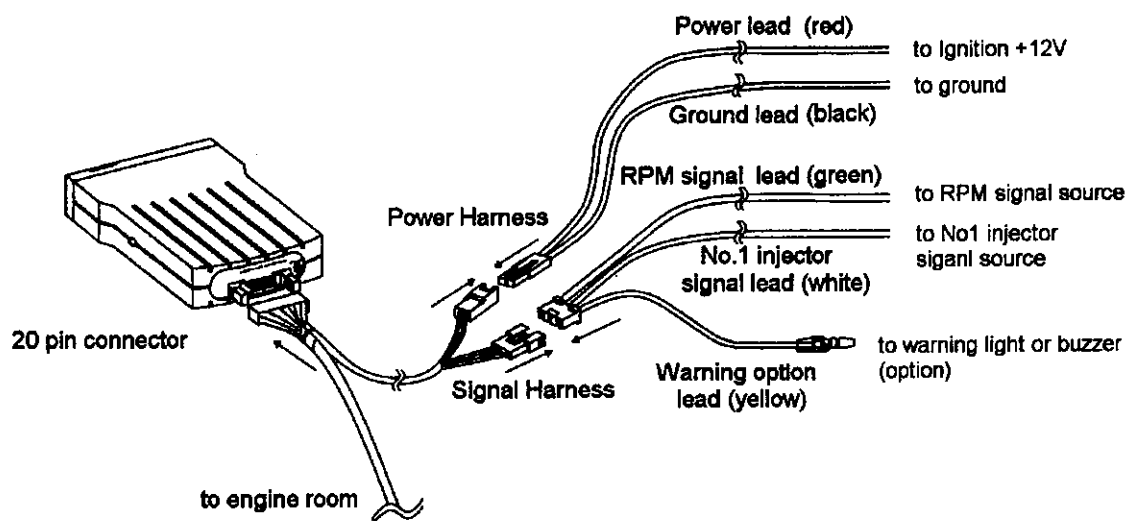

Signal Harness Wiring Procedure

- ①. Connect green wire from the Signal Harness to the engine RPM signal source on the vehicle.
- ②. Connect white wire from the Signal Harness to the No. 1 Injector signal source on the vehicle.
- ③. Connect the yellow Wire from the Signal Harness to (-) negative lead on a warning light or buzzer. (Optional)
- ④. Connect the Signal Harness to the Main Harness 3 pin connector.

Important

- The RPM Signal can be taken from the ECU Engine RPM signal wire, IG (-) negative wire in the Vehicle Diagnosis, or Engine RPM (tachometer) Test Connector. Please refer to the vehicle's service manual for the locations of the connectors.
- The Warning Option lead is used as a ground switch for a warning light (max load: 14Volts, 3.4Watts bulb) or a buzzer.

3-5. Controller Installation

Caution

- Be sure to mount the controller (head unit) inside of the vehicle away from moisture or excessive dust.
- Do not mount the controller in the area that is exposed to direct sunlight or near any heating vents.
- Make sure to mount the Controller unit where it does not interfere with vehicle operation.

Installation (Inside the vehicle)

- ①. Mount the Controller mounting bracket to the dashboard using provided screws or double-sided tape.
- ②. Connect the Main Harness 20 Pin connector to the back of the Controller (head Unit)
- ③. Mount the controller to the mounting bracket using the provided mounting screw.

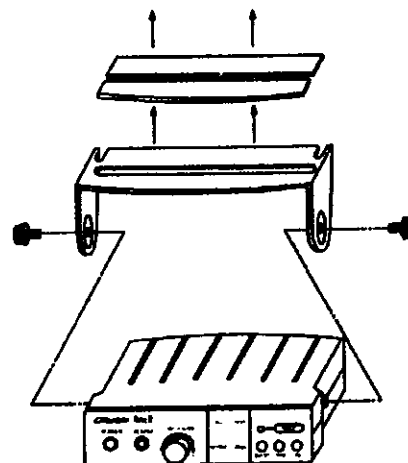
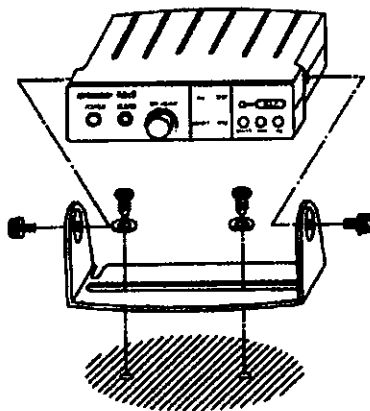

3-6. Final Installation Inspection

Please read the following and check all installation.

- Make sure that all connectors and hoses installed are properly connected.
- Make sure that all harnesses (wires) and hoses installed are tie wrapped away from any moving parts or exhaust system.
- Make sure that the Controller unit is securely mounted and does not interfere with the vehicle's operation.
- Make sure the parts that were removed to install this product are reinstalled.
- Reconnect the negative terminal of the battery.
- Turn the ignition to "ON" position to get fuel pressure, then check for any fuel leaks. If there are no leaks, start the engine and check for leak again.
- Make sure the battery is securely connected, and close the hood.

WARNING

- ⚠ After installation, check and make sure that there are no tools left in the vehicle. Tools left in the vehicle may be dangerous.
- ⚠ Be sure to inspect the fuel line for leaks, and wear before operating the vehicle. Improper installation in the fuel system is very dangerous.

This completes the Installation

4. Operation Instruction

Please read the following precautions thoroughly before starting the operation.

WARNING



When operating the vehicle, read over the vehicle owner's manual and drive safely.

Caution

- When tuning the fuel map, make sure to maintain a proper Air/Fuel ratio for the engine's application with A/F ratio meter. Improper programming of the fuel map can cause engine damage. **GReddy Performance Products, Inc. will not be held responsible or warranty any engine damage caused by improper tuning.**
- Do not insert anything other than a specified part in to the Data Link Interface on the back of the unit.
- This product does not calculate injector pulse at the same rate as the previous Rebic III Unit. Even with the same volume setting as the previous unit, the same fuel amount and injector pulse may not be achieved.

Important

- This Product is legal for sale or use in CA only for racing vehicles which may never be driven on a public highway.

4-1. Controller Functions

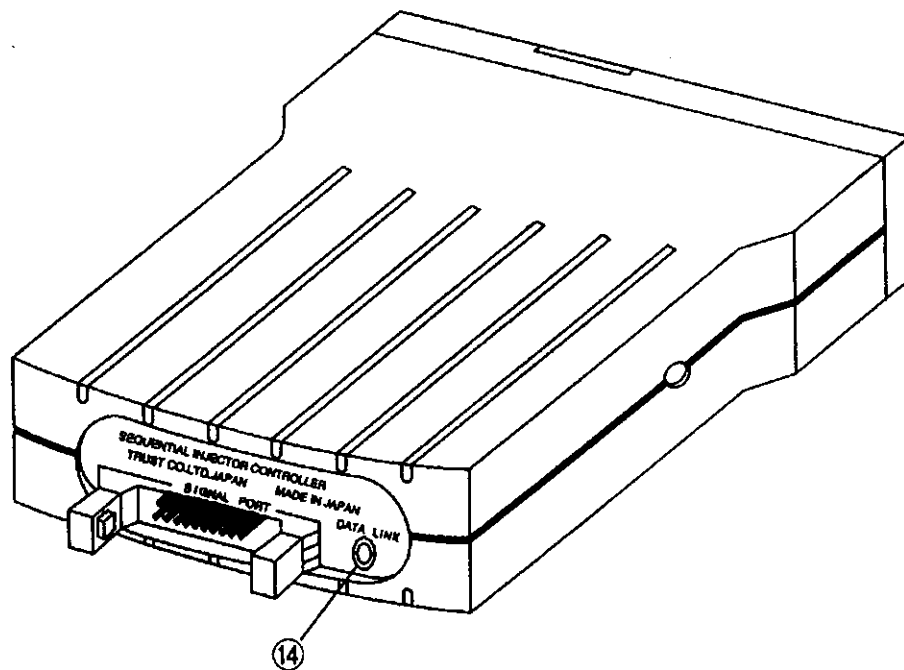
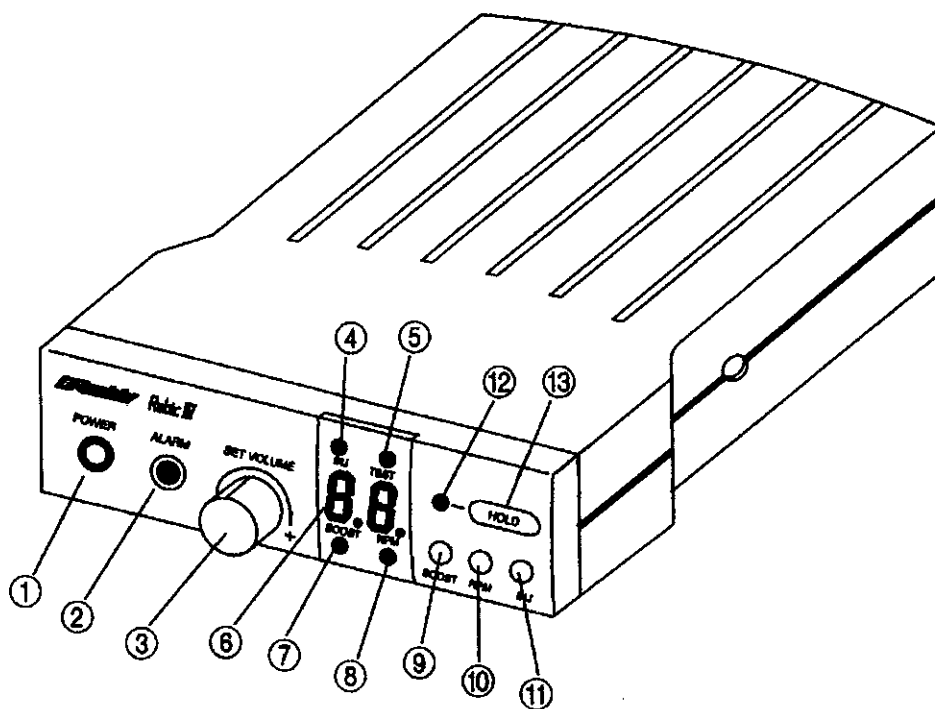

4-1. Controller Functions

1. **POWER Switch**
 - Turns the power ON/OFF.
 - Used to set each setting.
 - Used to return to "Run Mode".
2. **ALARM L.E.D.**
 - Illuminates, or flashes during setting.
 - Illuminates and beeps when any settings exceeds over the set warning point.
3. **SET Volume**
 - Push to switch modes, setting, and to locks-in settings.
 - Turn to set each value in all modes.
4. **IN L.E.D.**
 - Illuminates when the injector duty cycle is being displayed during "Run Mode", and flashes when injector(s) begin firing.
 - Illuminates, or flashes during setting.
5. **TEST L.E.D.**
 - Illuminates during Simulation Mode.
 - Illuminates, or flashes during setting.
6. **Digital display**
 - Displays Boost, RPM, or Injector Duty Cycle during "Run Mode".
 - Displays each setting value.
7. **BOOST L.E.D.**
 - Illuminates when the Boost is being displayed in "Run Mode".
 - Illuminates, or flashes during setting.
8. **RPM L.E.D.**
 - Illuminates when the RPM is being displayed in "Run Mode".
 - Illuminates, or flashes during setting.
9. **BOOST Switch**
 - Pressed to display the Boost in "Run Mode".
 - Used during setting and simulation.
10. **RPM Switch**
 - Pressed to display the RPM in "Run Mode".
 - Used during setting and simulation.
11. **INJ Switch**
 - Pressed to display the Injector Duty Cycle in "Run Mode".
 - Used during setting and simulation
12. **HOLD L.E.D.**
 - Flashes when the Peak Hold feature is being used.
 - Illuminates when Hold feature is being used.
13. **HOLD Switch**
 - Used to activate the Peak Hold, and Hold feature.
 - Used to set the Warning Point, and Lock feature.
14. **DATA LINK Interface**
 - Used for the Trust GRadis-9000 Data Logger.

4-2. Programming Flow Chart

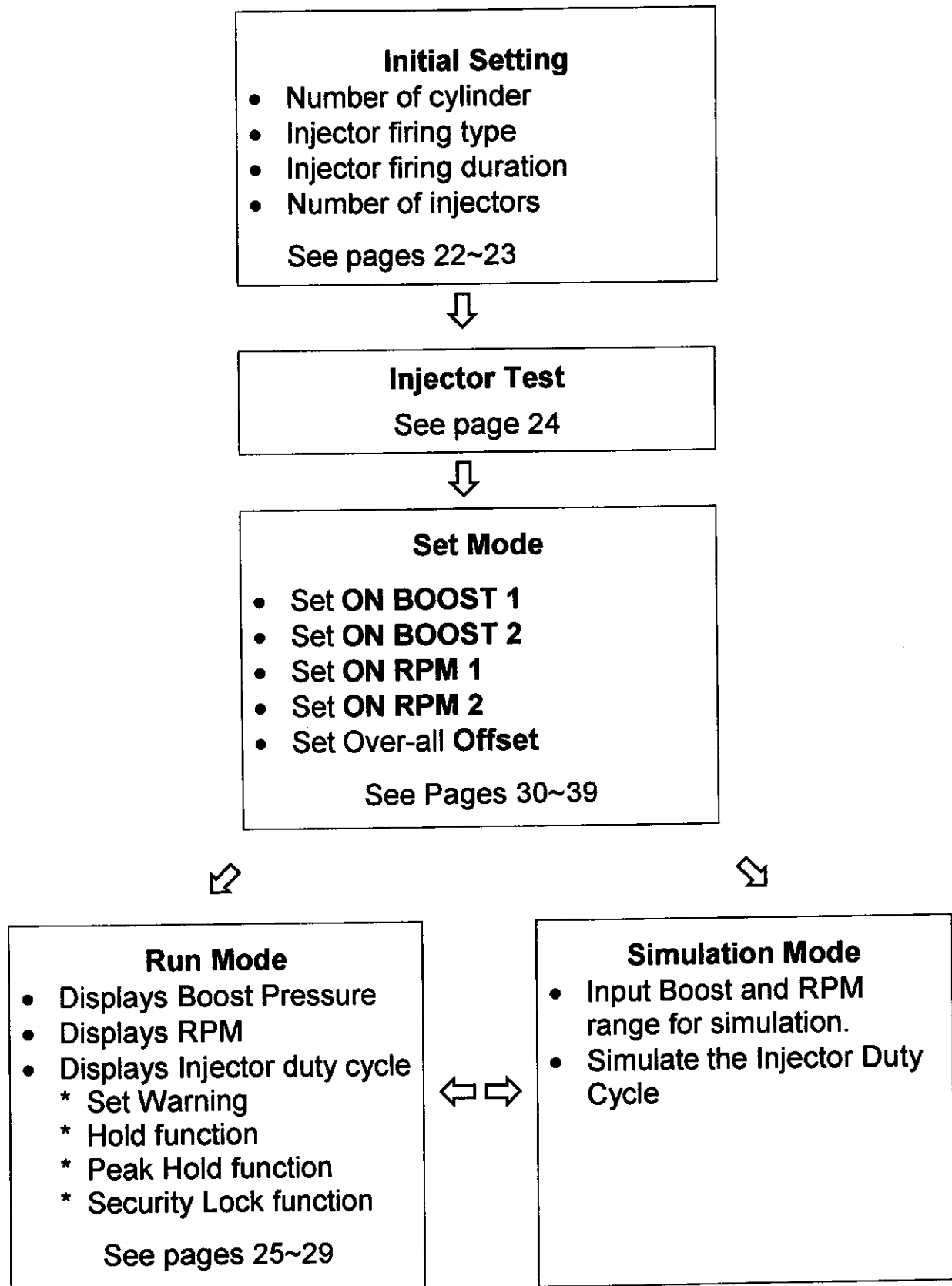

4-3. How to read the digital display

How to read BOOST Display

Digital LED Display										
Boost Pressure	-0.50 kg/cm ²	-0.15 kg/cm ²	-0.10 kg/cm ²	-0.05 kg/cm ²	0 kg/cm ²	0.05 kg/cm ²	0.10 kg/cm ²	0.15 kg/cm ²	2.0 kg/cm ²	3.0 kg/cm ²

How to read RPM Display

Digital LED Display								
RPM	0 rpm	100 rpm	500 rpm	1000 rpm	5000 rpm	9900 rpm	10000 rpm	12000 rpm

How to read Injector Duty Cycle Display

Digital LED Display							
Injector Duty Cycle	0 %	1 %	7 %	10 %	50 %	99 %	100 %

Conversion Formula

Boost pressure:

To convert kg/cm² to psi: multiply kg/cm² by 14.22

To convert psi to kg/cm²: multiply psi by 0.0703

Example:

1) .95 kg/cm² = .95 X 14.22 = 13.5 psi

2) 10 psi = 10 X 0.0703 = .70 kg/cm²

4-4. Initial Setting

Setting Procedure

- ①. When the POWER is turned "ON", the Current "number of Cylinder" will be displayed. (To reset, press the POWER and SET volume simultaneously for 5 sec.)

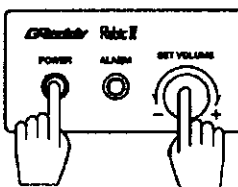

Turn the SET volume to the number of cylinders on the engine being used.

「 c . 2 」	2 Cylinder
「 c . 3 」	3 Cylinder
↓	↓
「 R . 2 」	Rotary Engine 2 Rotor
「 R . 3 」	Rotary Engine 3 Rotor

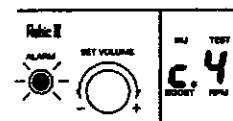

4 Cylinder shown above

- ②. Press the SET volume to program the Injector Firing Type. Turn the SET volume to desired Injector Firing Type.

「 S i 」	Sequential Firing
「 r d 」	Group Firing
「 n o 」	Fixed Injector Duration Firing

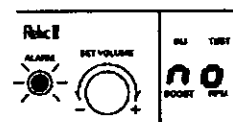

Fixed Injector Duration Firing shown above

- ③. For the Fixed Injector Duration Firing, Press the SET volume to Set the Injector drive time. Turn the SET volume to desired duration.

4-4. Initial Setting (cont.)

[6]	6 m s
[7.5]	7.5 m s
[10]	10 m s
[15]	15 m s

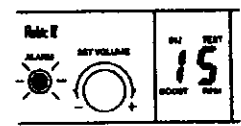

15 ms setting shown above

(above is only use for [NO] setting)

- ④. Press the SET volume to program the number of the injectors being used. (If Sequential Firing is used, the unit will display the same number of the cylinders. This number is not adjustable.)
Turn the SET volume to the number of the Injectors being used.

[J.1]	1
[J.2]	2
↓	↓
[J.8]	8

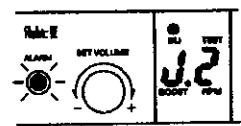

2 injector setting shown above

- ⑤. Press the SET volume to complete the Initial Setting and to return to the RUN Mode.

Important

- The Injector pulse duration for the Sequential and Group firing changes as the engine RPM changes, so it will not operate the same as the previous Rebic III. To operate the unit like the Rebic III, use Fixed Injector Duration Firing.
- When installing the Sub-Injectors on the Intake Manifold (1 for each cylinder), use Sequential firing setting.
- When installing the Sub-Injectors on the Charge Pipe before the throttle, use Group firing setting.
- To operate the unit like the Rebic III, use Fixed Injector Duration firing, and set the duration to 15 ms.

4-5. Injector Test

Test to make sure the injector(s) fire. Test one Injector at a time.

Test Procedure

- ①. From RUN mode press the SET volume for 2 sec. to go to SET Mode. ("SE" will display)

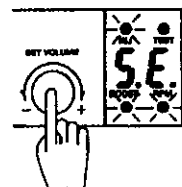

- ②. Press the INJ switch for 2 sec. until "IJ" is displayed.

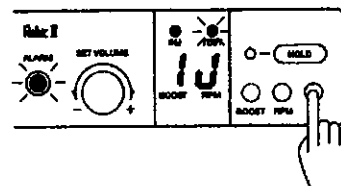

- ③. Turn the SET volume to the Injector to be tested.

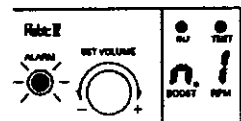

- ④. Rev the engine up to 3000~4000 RPM, then while pressing the INJ switch, press the SET volume for 1~2 sec. At this time, "FF" will display indicating maximum flow from the injector selected. Due to excess fuel being injected, there will be a slight engine hesitation. (Please be aware that if SET/INJ switch is depressed too long, the engine will stall, and may cause engine damage.)

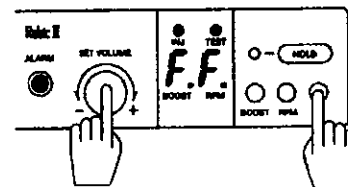

- ⑤. Repeat steps ③-④ for all Injectors. (One by one)
- ⑥. Press the POWER switch to return to RUN Mode.

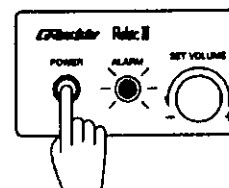

4-6. RUN Mode

RUN Mode is used when operating the vehicle. During the operation of the vehicle, this product will fire the sub-injectors at the programmed setting. Also, during the RUN mode, a real time Boost, RPM, or Injector Duty Cycle can be displayed.

4-6-1. How to set the RUN Mode Display

BOOST Display

While in RUN Mode, by pressing the BOOST switch, the BOOST LED will illuminate and the boost pressure will be displayed. When the Injector starts to fire, the INJ LED will start to flash.

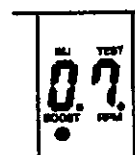

0.75 kg/cm² shown above

RPM Display

While in RUN Mode, by pressing the RPM switch, the RPM LED will illuminate and engine RPM will be displayed. When the Injector starts to fire, the INJ LED will start to flash.

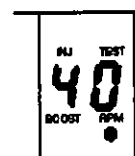

4000 RPM shown above

Injector Duty Cycle Display

While in RUN Mode, by pressing the INJ switch, the INJ LED will illuminate and engine Injector Duty Cycle will be displayed. When the Injector starts to fire, the INJ LED will start to flash.

- When the Injector duty cycle become 100%, "FF" will be displayed with ALARM LED and a "beep".

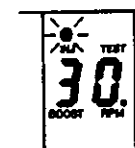

30% Injector duty cycle shown above

4-6-2. How to set the Warning

If for some reason, the Boost, RPM, or Injector Duty Cycle exceeded over the set Warning point, the Rebic IV will warn the user with the ALARM L.E.D. and a "beep".

How to Set the Warning

- ①. While in the RUN Mode, Press the POWER and HOLD switch simultaneously to go to ALARM Mode. (ALARM L.E.D. will illuminate)

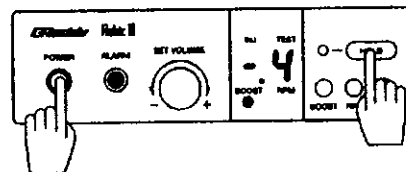

- ②. Press the BOOST switch to set the Boost Warning. While the Boost is displayed, turn the SET volume to the desired Boost Warning point.

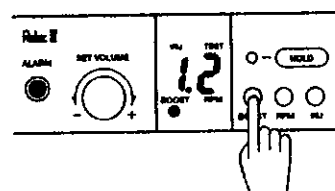

- ③. Press the RPM switch to set the RPM Warning. While the RPM is displayed, turn the SET volume to the desired RPM Warning point.

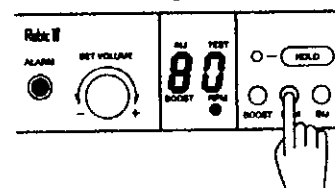

- ④. Press the INJ switch to set the Injector Duty Cycle Warning. While the Injector Duty Cycle is displayed, turn the SET volume to the desired RPM Warning point.

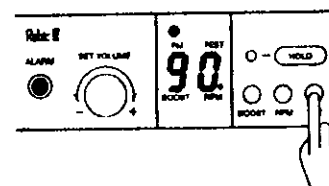

- ⑤. Press the POWER switch to go back to RUN Mode (or wait for 5 sec.).

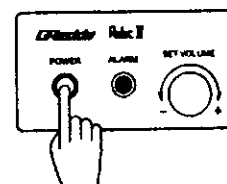

4-6-3. Security Lock Function

This Security Lock feature allows the user to lock the controller to avoid improper or unauthorized programming.

While the controller is locked, the unit will still allow the user to select the RUN mode displays, and to operate the Peak Hold and Simulation Mode.

How to lock

- ①. In RUN mode, press the POWER and HOLD switch down simultaneously for 5 sec.

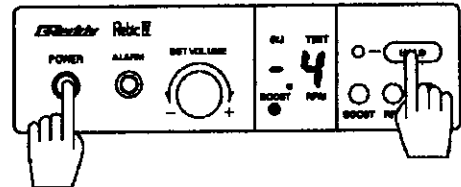

- ②. "Lc" will display indicating that the controller is "locked". After the L.E.D. flashes, the unit will return to the RUN mode.

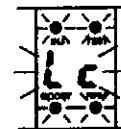

How to unlock

- ①. In RUN mode, press the POWER and HOLD switch down simultaneously for 5 sec.

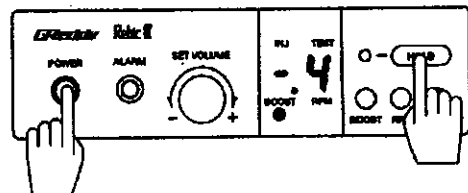

- ② "Un" will display indicating that the controller is "unlocked" and the unit will return to the RUN mode.



4-6-4. HOLD and PEAK HOLD Function

HOLD Function

This feature allows the user to “hold” the Boost, RPM, and Injector Duty Cycle data, at any desired time while operating the vehicle.

HOLD Operation

①. While in run mode (operating the vehicle), press the HOLD switch once to “hold” the data at the desired time. (HOLD L.E.D. will illuminate)

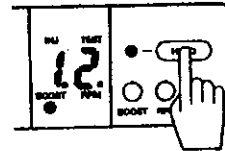

②. The data that was “hold” will display, and by pressing BOOST, RPM, or INJ switch, each “hold” data can be displayed.

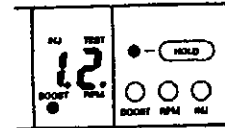

③. Press the HOLD switch again to reset the HOLD function.

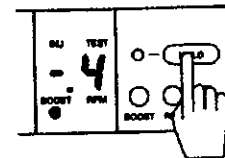

4-6-4. HOLD and PEAK HOLD Function

PEAK HOLD Function

This feature allows the user to “hold” the maximum Boost, RPM, and Injector Duty Cycle data recorded while operating the vehicle.

PEAK HOLD Operation

①. While in RUN mode, press the HOLD switch for 2 sec. to set the PEAK HOLD mode. (HOLD L.E.D. will flash)

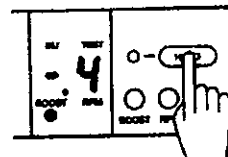

②. The maximum data recorded will display, and by pressing BOOST, RPM, or INJ switch, each “Peak Hold” data can be displayed.

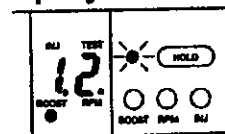

③. Press the HOLD switch again to reset the PEAK HOLD function.

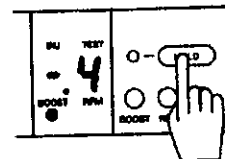

4-7. SETTING MODE

SETTING Mode is use to program each of the necessary settings, in order for the Sub-injector(s).

This controller allows the user to choose 2 points of boost pressure (for Boost Fuel Map), and 2 points of engine RPM (for RPM Fuel Map), to accurately tune the sub-injector(s) to the desired duty cycle.

- ◆ Boost Fuel Map is the initial fuel map for the sub-injector(s). This is similar to the GReddy Rebic III unit. From the selected ON BOOST and ON RPM, the Rebic IV creates a linear graph to the selected SET BOOST 1 and INJ%1.
The SET BOOST 2 and INJ%2 is used to “fine-tune” the fuel map to achieve a proper air/fuel ratio, as the Rebic III Simulator would do.
(See BOOST FUEL MAP graph on page 31)
- RPM Fuel Map is used for further “fine-tuning” of the sub-injector’s fuel map, for proper air/fuel ratio. Select either SET BOOST 1 or SET BOOST 2 as a fuel map reference point. You can then modify the initial fuel map from the designated START RPM point to the SET RPM 1 point, with the new desired INJ%3 value.
(See BOOST FUEL MAP graph on page 31)

Rebic IV allows the user to run the vehicle and change any settings while in SETTING Mode for “change on the fly” programming.

4-7 SETTING MODE

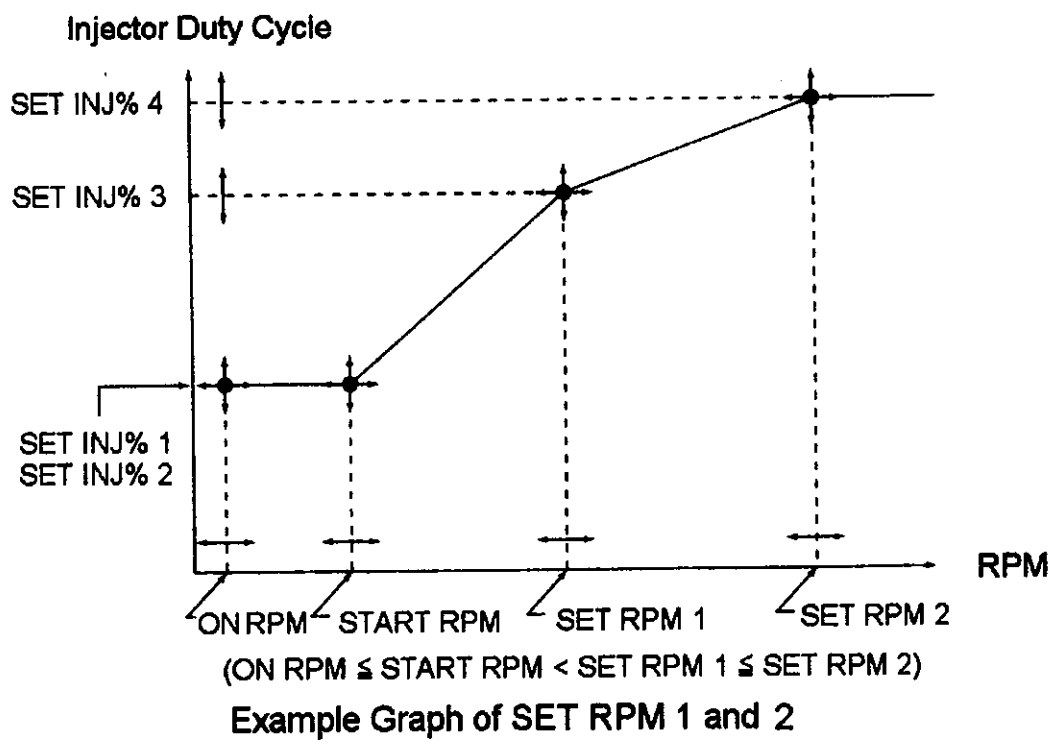
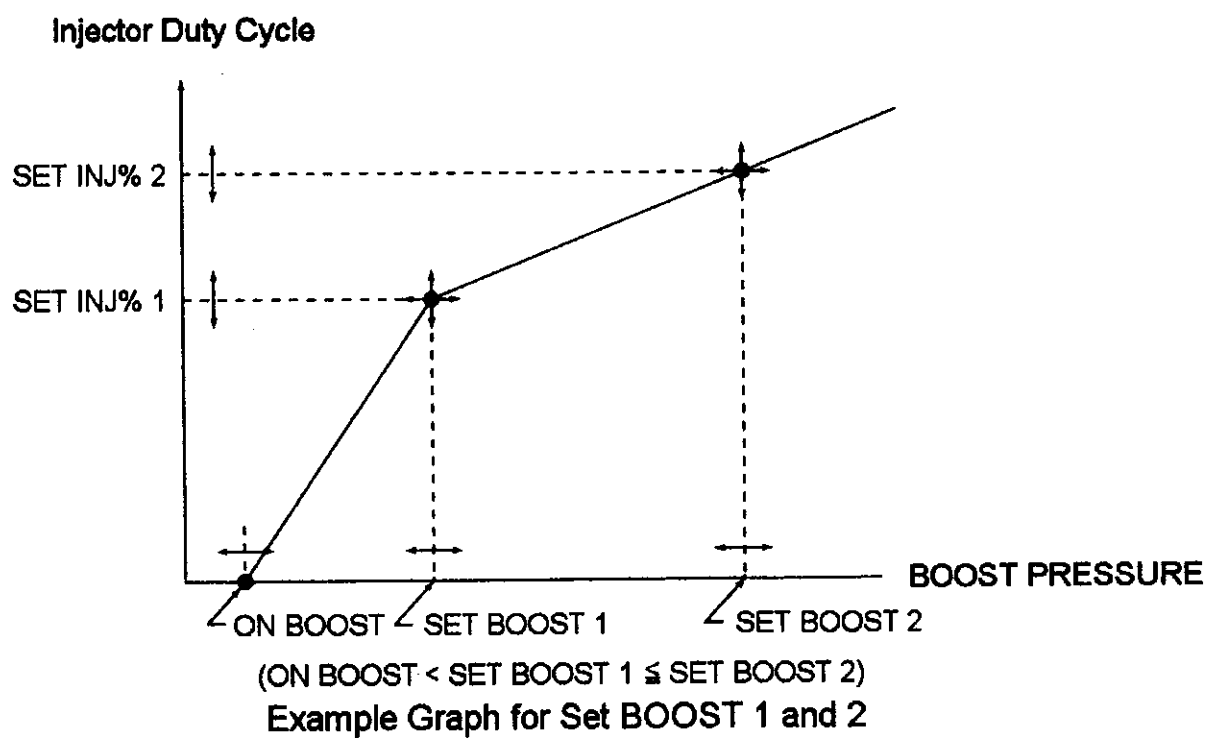

4-7-2. SETTING MODE Description

ON RPM ••••• One of two settings that determine when the injector(s) can start firing. When the engine rpm exceeds this value the injectors can start to fire.

ON BOOST ••••• Second of two setting that determine when the injector(s) can start firing. When the intake manifold boost pressure exceeds this value the injector(s) can start to fire.

Example: Set ON BOOST to where the Air/Fuel ratio starts to get lean.

SET BOOST, INJ%1 ••• A desired Injector Duty Cycle can be programmed at a determined Boost Pressure.

Example: Set the SET BOOST 1 to your predetermined "LO Boost" setting of you PRefec (boost controller) and then set the INJ%2 to the desired injector duty cycle at that SET BOOST 1 point.

SET BOOST, INJ%2 ••• A desired Injector Duty Cycle can be programmed at a 2ND determined Boost Pressure.

Example: Set the SET BOOST 2 to your predetermined "Hi Boost" setting of you PRefec (boost controller) and then set the INJ%2 to the desired injector duty cycle at that SET BOOST 2 point.

Select SET BOOST ••• Select either "SET BOOST 1" or "SET BOOST 2" as a reference point to modify a section of the Fuel Map to a desired injector duty cycle at a specific engine RPM.

START RPM ••••• A setting that determines the starting point which to begin modifying the fuel map. The injector duty cycle can be modified this desired RPM.

Example: Set the START RPM to the point where the Air/Fuel ratio starts to become lean (while under constant boost).

SET RPM1, INJ%3 ••• A desired Injector Duty Cycle can be programmed to a desired engine RPM.

Example: Set the SET RPM 1 to match the vehicle's "rev limit. Then program the INJ%3 a value which delivers the proper Air/Fuel ratio.

SET RPM2, INJ%4 ••• A desired Injector Duty Cycle can be programmed to a 2nd desired engine RPM.

Example: Used only when further "fine tuning" is necessary. Set the SET RPM 2 to another critical rpm point.

4-7-3. Setting Procedure

To program each of the setting in the SET Mode, please refer to the following procedure.

How to Program

Example: Setting the Set Boost mode 1

①. In RUN mode, press down the SET volume for 2 sec. "SE" will display.



②. Press the BOOST switch once. The current ON RPM will display.

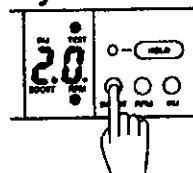

③. Turn the SET volume to set to a desired RPM value. (display will flash)

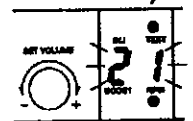

④. Press the SET volume once to lock the desired value. (Display will stop flashing)

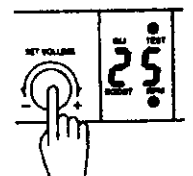

⑤. Press the BOOST switch once. The current ON BOOST will display.

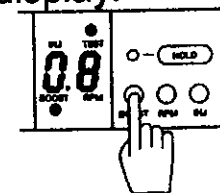

⑥. To set the ON BOOST repeat the steps ③ and ④.

⑦. Then set the SET BOOST1, INJ%1.

⑧. If the all the settings are complete, press the POWER switch to return to RUN mode. If the settings are not complete, press the BOOST switch to return to step ②.

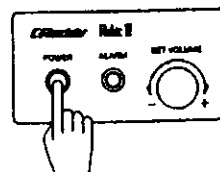

4-7-4. Set Boost Mode 1

Setting Procedure

①. While "SE" is displayed, press the BOOST switch once. The current ON RPM will display, then turn the SET volume to set to a desired ON RPM value. Press the SET volume once to lock the desired value.

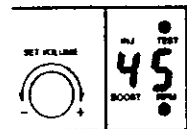

②. Press the BOOST switch once. The current ON BOOST will display, then turn the SET volume to set to a desired ON BOOST value. Press the SET volume once to lock the desired value.

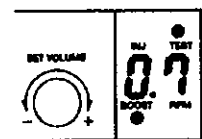

③. Press the BOOST switch once. The current SET BOOST 1 will display, then turn the SET volume to set to a desired SET BOOST 1 value. Press the SET volume once to lock the desired value. (Make sure SET BOOST 1 setting is higher than ON BOOST setting)

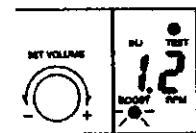

④. Press the BOOST switch once. The current INJ %1 will display, then turn the SET volume to set to a desired INJ %1 value. Press the SET volume once to lock the desired value.

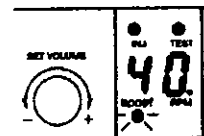

⑤. Press the POWER switch to return to RUN mode.

4-7-5. Set Boost Mode 2

Setting Procedure

①. While "SE" is displayed, press the BOOST switch for 2 sec. The current SET BOOST 2 will display, then turn the SET volume to set to a desired SET BOOST 2 value. Press the SET volume once to lock the desired value. (Make sure SET BOOST 2 setting is higher than SET BOOST 1 setting)



②. Press the BOOST switch once. The current INJ %2 will display, then turn the SET volume to set to a desired INJ %2 value. Press the SET volume once to lock the desired value.

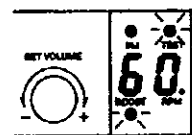

③. Press the POWER switch to return to RUN mode.

Injector Duty Cycle

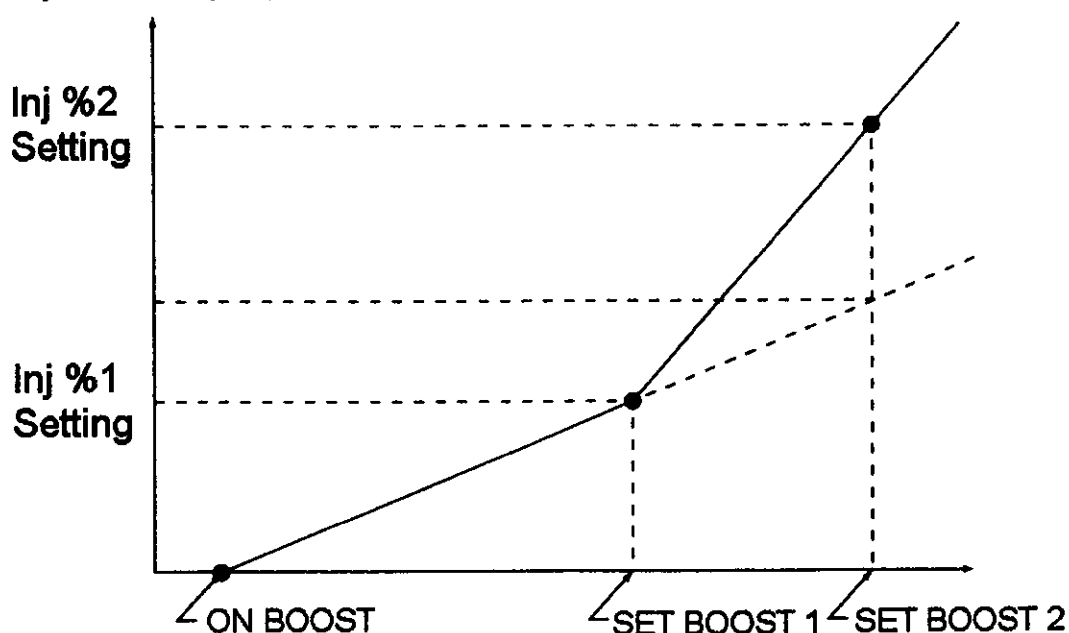

4-7-6. Set RPM Mode 1

Setting Procedure

①. While "SE" is displayed, press the RPM switch once. The current SET BOOST will display, then turn the SET volume to set to a desired SET BOOST value. Press the SET volume once to lock the desired value.

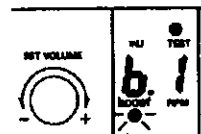

②. Press the RPM switch once. The current START RPM will display, then turn the SET volume to set to a desired START RPM value. Press the SET volume once to lock the desired value.

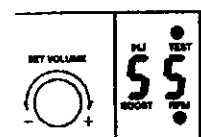

③. Press the RPM switch once. The current SET RPM 1 will display, then turn the SET volume to set to a desired SET RPM 1 value. Press the SET volume once to lock the desired value. (Make sure SET RPM 1 setting is higher than ON RPM setting)

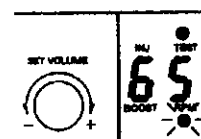

④. Press the BOOST switch once. The current INJ %3 will display, then turn the SET volume to set to a desired INJ %3 value. Press the SET volume once to lock the desired value.

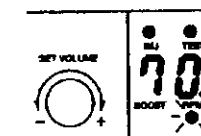

⑤. Press the POWER switch to return to RUN mode.

4-7-7. Set RPM Mode 2

Setting Procedure

- ①. While "SE" is displayed, press the RPM switch for 2 sec. The current SET RPM 2 will display, then turn the SET volume to set to a desired SET RPM 2 value. Press the SET volume once to lock the desired value. (Make sure SET RPM 2 setting is higher than SET RPM 1 setting)
- ②. Press the RPM switch once. The current INJ %4 will display, then turn the SET volume to set to a desired INJ %4 value. Press the SET volume once to lock the desired value.
- ③. Press the POWER switch to return to RUN mode.

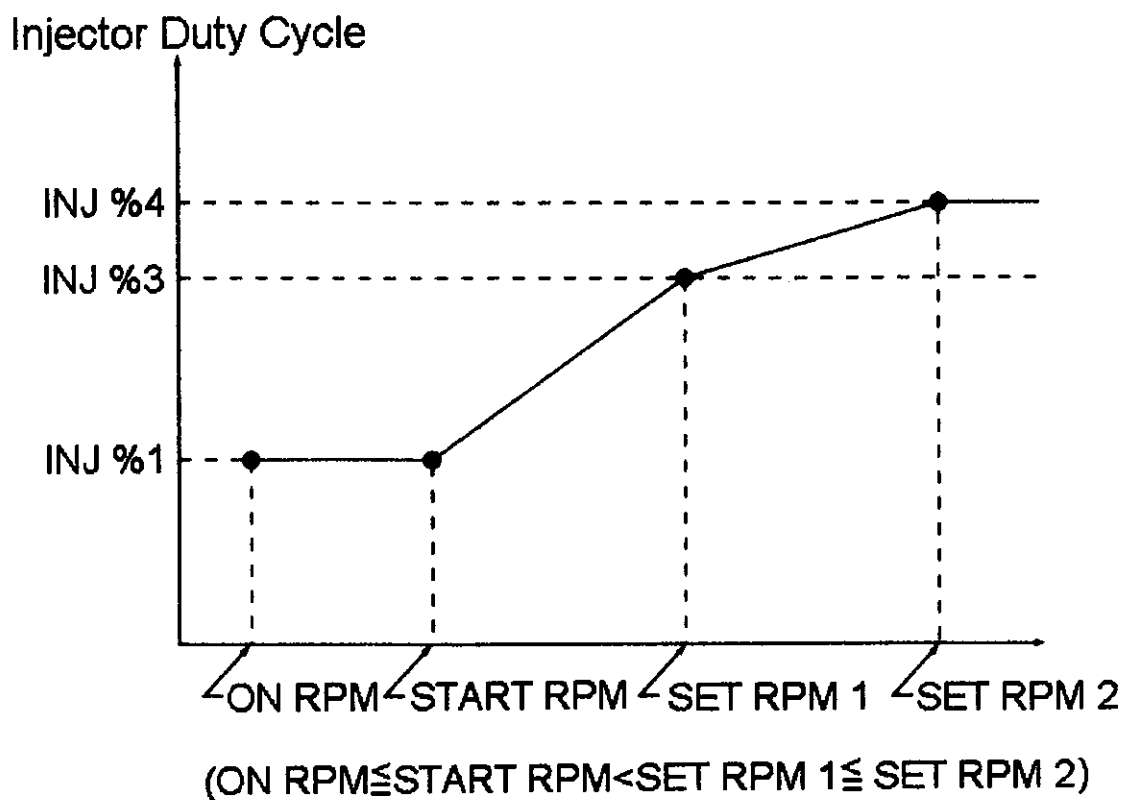

4-7-8. Total Offset Function

The Injector Duty Cycle values that was programmed in the previous procedures can be shifted up or down by this Total Offset Function.

Total Offset Procedure

- ①. While "SE" is displayed, press the INJ switch once. The current TOTAL OFFSET will display, then turn the SET volume to set to a desired TOTAL OFFSET value. Press the SET volume once to lock the desired value. (When the TOTAL OFFSET value is negative, ALARM LED will flash.)

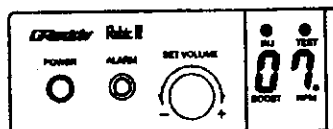

7% TOTAL OFFSET

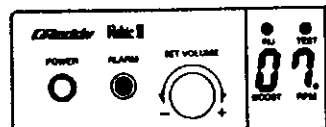

-7% TOTAL OFFSET

- ②. Press the POWER switch to return to RUN mode.

TOTAL OFFSET CALCULATION

$$\text{Inj. Duty Cycle after OFFSET} = \text{Inj. Duty Cycle before Offset} + \text{OFFSET}$$

Injector Duty Cycle

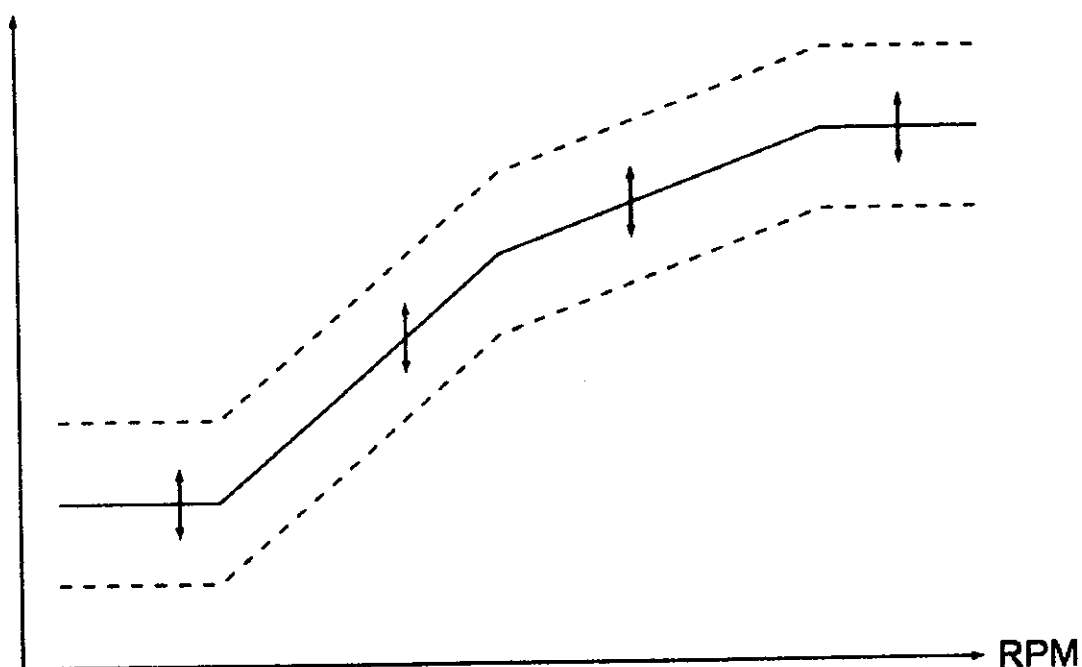

TOTAL OFFSET TABLE

4-8. Simulation Mode

Simulation Mode allows the user to test and simulate the programmed Injector duty cycle (Boost and RPM setting) without running the vehicle.

Simulation Mode Procedure

- ①. While in run Mode, press the SET volume once.

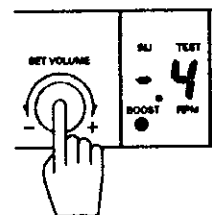

- ②. Press the BOOST switch once, and set to a desired boost value to simulate by turning the SET volume.

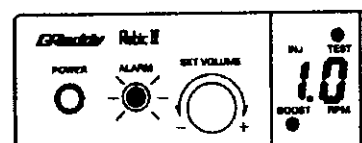

Above: Showing 1.0kg/cm²

- ③. Press the RPM switch once, and set to a desired rpm value to simulate by turning the SET volume.

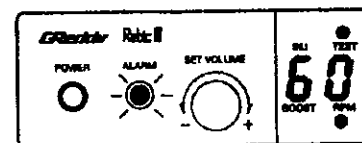

Above: Showing 6000 rpm

- ④. Press the INJ switch to display the injector duty cycle at above specified value. (boost and rpm).

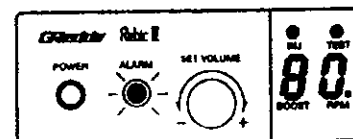

Above: Showing 80% inj. duty cycle

- ⑤. Repeat steps ②~④ to simulate at other setting. Press POWER switch to quit Simulation Mode and to return to RUN mode.

4-8. Simulation Mode

Simulation Example

ON BOOST= 0.6 kg/cm² ON RPM= 3000 rpm
 SET BOOST1= 10. kg/cm² INJ%1= 40 %
 SET BOOST2= 1.2 kg/cm² INJ%2= 70 %
 Select SET BOOST= b 1 or b 2
 START RPM= 4000 rpm
 SET RPM1= 8000 rpm INJ%3= 60 %
 SET RPM2= - - - - rpm INJ%4= - - %
 TOTAL OFFSET 0 %

	0.6	0.7	0.8	0.9	1.0	1.1	1.2	1.3	1.4
2500	0	0	0	0	0	0	0	0	0
3000	0	10	20	30	40	55	70	85	F.F
3500	0	10	20	30	40	55	70	85	F.F
4000	0	10	20	30	40	55	70	85	F.F
4500	0	11	21	32	43	58	74	90	F.F
5000	0	11	23	34	45	62	79	96	F.F
5500	0	12	24	36	48	65	83	F.F	F.F
6000	0	13	25	38	50	69	88	F.F	F.F
6500	0	13	26	39	53	72	92	F.F	F.F
7000	0	14	28	41	55	76	96	F.F	F.F
7500	0	14	29	43	58	79	F.F	F.F	F.F
8000	0	15	30	45	60	83	F.F	F.F	F.F
8500	0	15	30	45	60	83	F.F	F.F	F.F

4-8. How to Calculate the Fuel Injected

How to calculate the fuel injected

From the injector duty cycle, calculate the amount of the fuel injected:

$$\frac{\text{Sub-injector Size X Number of Sub-injectors used X Injector Duty Cycle}}{100}$$

= the amount of the fuel injected (cc/min)

Example:

if 4 X 450(cc/min) injectors were used, and 80% of the injector was injected;

$$450(\text{cc/min}) \times 4 (\text{injectors}) \times 80\% \div 100 = 1440 (\text{cc/min})$$

Rebic IV will inject 1440 (cc/min).

As shown above, you can calculate the amount of the fuel injected, or how to program Rebic IV to achieve the desired fuel amount using the Simulation mode.

4-9. Setting Reset

Reset Procedure

This mode will Reset the Rebic IV to the Factory Preset Program. This is used when you need to reprogram the settings.

- This will not reset the Initial Settings.
- To set the Injector firing type, Injector firing duration, and number of injectors, refer to pages 22~23

①. While in Setting Mode ("SE" displayed), Hold the POWER switch down for 5 sec.

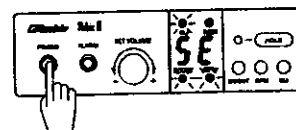

②. After 5 sec, the display and the L.E.D.s will flash with a "beep", and return to "SE" mode.



Factory Preset Program

ON RPM	2 0 0 0 rpm	Select SET BOOST	b 1
ON BOOST	0.6 kg/cm ²	START RPM	4 0 0 0 rpm
SET BOOST1	1.0 kg/cm ²	SET RPM1	8 0 0 0 rpm
INJ%1	4 0 %	INJ%3	6 0 %
SET BOOST2	1.0kg/cm ² (=SET BOOST1)	SET RPM2	8000rpm(=SET RPM1)
INJ%2	4 0 % (=INJ%1)	INJ%4	6 0 % (=INJ%3)
OFFSET	0 %		