

You can purchase this part at: <http://thmotorsports.com>

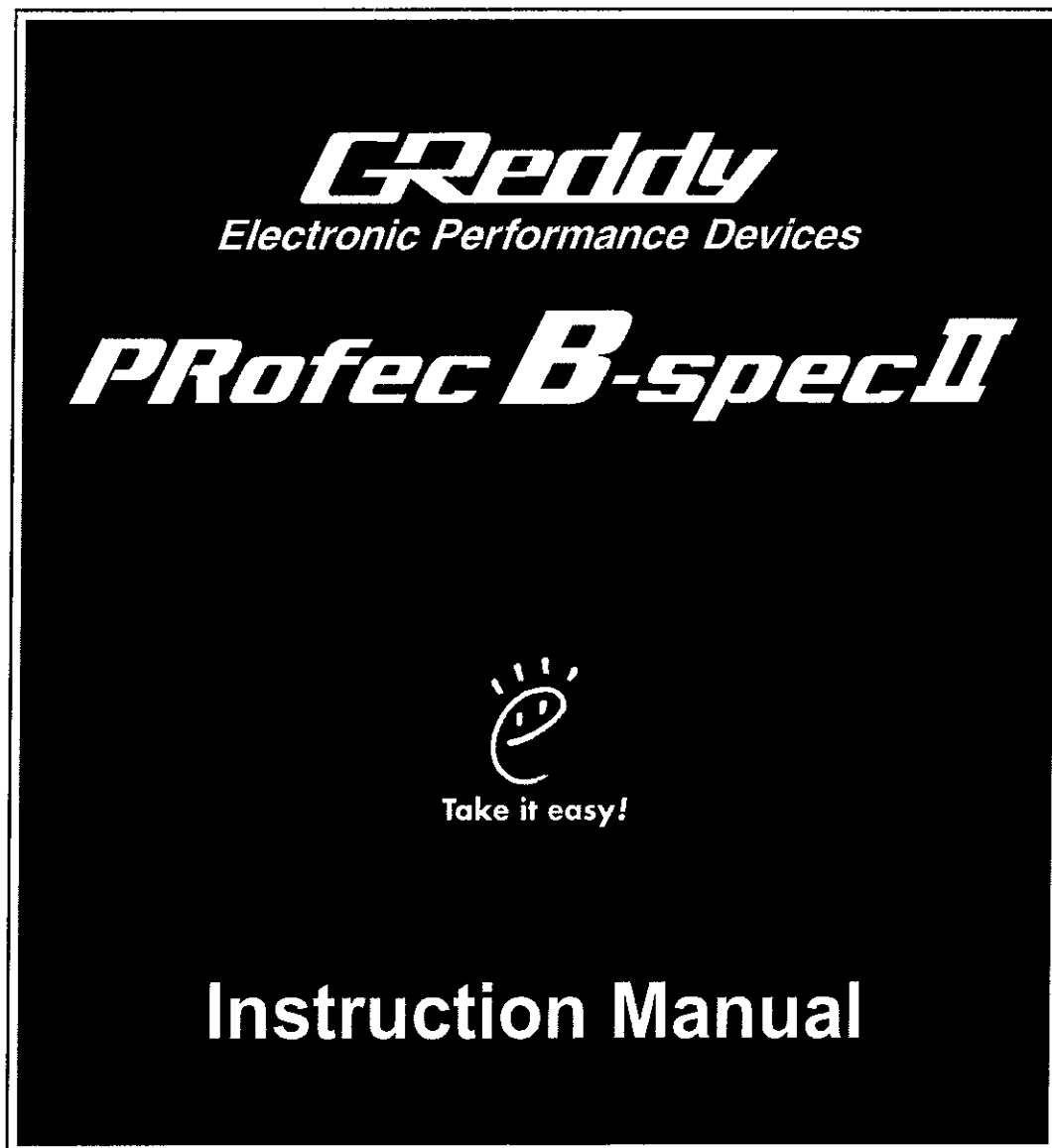

More installation manuals at: [www.thmotorsports.net](http://www.thmotorsports.net)

**Important Information**

**Please read**

Please read this instruction manual carefully and proceed with the installation ONLY if you fully understand this manual. Make sure to pay close attention to all the "Important!", "Warning!" and "Caution!" messages throughout the manual.

**Important!**



- This product is for off-road vehicle use only, which may never be driven on a public highway.
- This product is only for vehicles with 12V (battery) systems.

**Warning**









- ⚠ Installation and tuning of this product should only be performed by a trained specialist who is very familiar with the automobile's mechanical, electrical and fuel management systems. If installed by an untrained person, it may cause damage to the unit as well as the vehicle.
- ⚠ When mounting this product in the vehicle, be sure the unit does not interfere with the driver's view and normal operation of the vehicle.
- ⚠ When using soldering iron and other tools for installation, be sure you read and understand the tool's user manual first. Misuse of these tools may cause injuries.
- ⚠ When working on the electrical wires, make sure to disconnect the negative terminal side of the battery on the vehicle.
- ⚠ When increasing the boost, be sure not to overboost. Overboosting may cause damage to the engine.
- ⚠ Be sure to find out what the safe boost pressure limit is for the vehicle before installing this product.
- ⚠ Trust Co. Ltd. and GReddy Performance Products, Inc. are not responsible for any engine damage caused by overboosting (increased boost over the safe limit).
- ⚠ Never tune the Profec B-spec II while the vehicle is moving.

**Important Information**

**Please read**

-  Never tune the Profec B-spec II on public highway. This may be dangerous to you as well as others on the road.
-  When tuning and operating the vehicle in a garage, be sure that the garage is equipped with a proper ventilation system.
-  After installation and tuning, be sure to clean up everything that would interfere with the driver. Tools and/or wires may interfere with the driver and may cause accidents.

**⚠ Caution**

-  Improper tuning of the Profec B-spec II may cause damage to the engine.
-  GReddy Performance Products, Inc. will not be responsible for any damage caused by improper installation or tuning.
-  Tuning should be performed only by a experienced technician who fully understands the vehicle s turbo system and fuel management requirement for the engine being tuned.
-  Always use a proper air/fuel ratio meter when tuning the Profec B-spec II to ensure safe boost level.  
Installation of this product requires modification of the vehicle s electrical system.
-  When making wire connections, be sure to remove the key from the ignition, and disconnect the negative terminal of the battery.
-  Never short out the system. It can damage the unit as well as the vehicle s electrical system.
-  Read and fully understand the wiring diagram before making any wire connection.
-  When connecting the connectors, push it in all the way until you hear them click in together.

Parts List

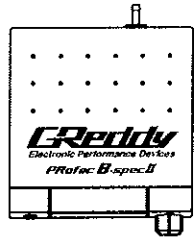

Main Unit

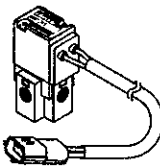

Valve Unit

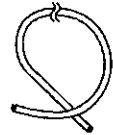

4mm Hose (2m)

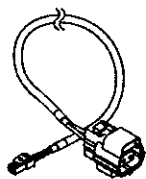

Valve Unit Harness (2.5m)



Power Harness (1.0m)

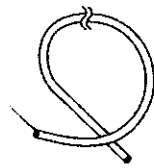

6mm Hose (1m)



M6 Bolt x 1  
Rubber Washer x 2

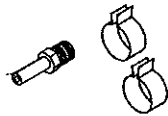

6mm Hose Fitting x 2  
Hose Clamp x 2

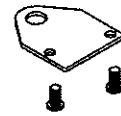

Bracket  
M4 Bolt x 2



3 Way Fitting



Double Sided Tape

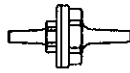

Air Filter



Instruction Manual

Please make sure all the parts listed above are included in the box. If there are any items missing, please contact your TRUST/GReddy authorized dealer where this unit was purchased.

## Product Features

- LCD screen to monitor boost pressure at real time.
- Controls boost up to 300kPa (43.5psi) (This may vary on different turbo systems)
- There are 2 preset settings that can be selected by a single switch.
- The response and the consistency of the boost can be adjusted by using the GAIN, START BOOST settings.
- A built in WARNING feature will alert the driver when the boost exceeds the set boost pressure with an alarm and a message in the display.
- When the WARNING feature is activated, the LIMITER feature can lower the boost to a safe pressure.
- PEAK boost feature will allow the user to check the highest boost recorded.
- The optional Remote switching system can be used to select the HI/LO boost mode. (Sold separately)

## Before Installation

**Please read**

### Tools required for installation

- |                  |                   |                              |          |
|------------------|-------------------|------------------------------|----------|
| ■ Voltage tester | ■ Wire cutter     | ■ Screw drivers (+,-)        | ■ Pliers |
| ■ 10mm wrench    | ■ Electrical tape | ■ Solder, and Soldering iron |          |

- Make sure the engine has cooled down before working under the hood.
- Take the key out of the ignition switch and disconnect the negative terminal of the battery.
- Before mounting the Valve Unit, be sure the supplied pressure hose is long enough to reach them.
- Locate the actuator/wastegate, factory boost controlling solenoid valve, and fuel pressure regulator or true pressure source before installation.

### To the installer

- After the installation, please make sure that you give this instruction manual to the owner of the vehicle.

**Installation Diagram (Actuator Type)**

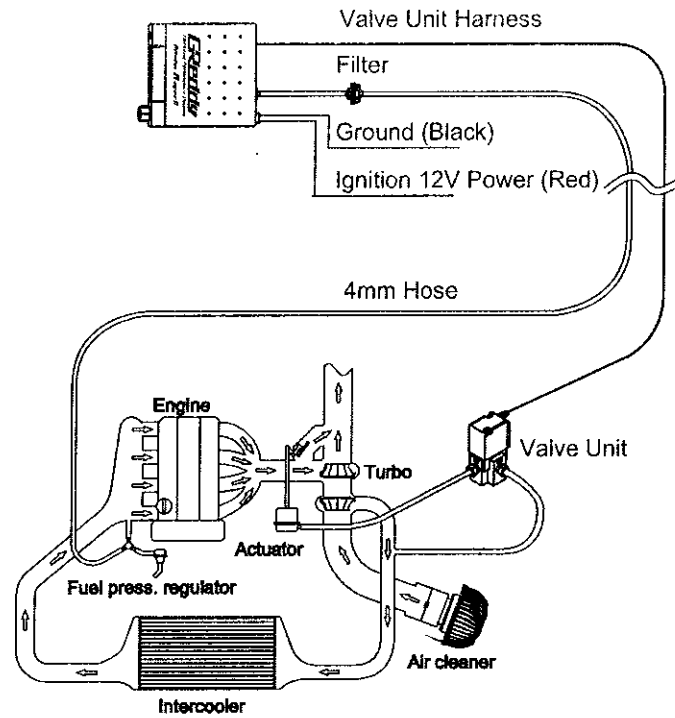

### Connection to the Intake Manifold

1. Cut the vacuum line on the fuel pressure regulator and install the supplied three way-fitting.
2. Install the supplied 4mm hose to the three way-fitting and route the hose in to the passenger compartment through the firewall.

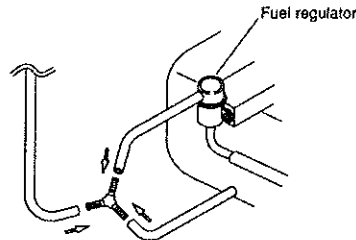

#### Important

- Please make sure that the 4mm hose is secured with a zip ties after the installation to prevent them from disconnecting.
- Toyota's JZ engines and Mitsubishi's 4G63 engine have fuel pressure controlling solenoid valves. For these vehicles, make sure to get pressure from the line between the intake manifold and the solenoid.
- When routing the 4mm hose through the firewall, make sure not to kink this hose. Kinked hose will cause the unit not to function properly.

### Connection to the Main Unit



1. Connect 4mm hose that was routed through in to the passenger compartment to the filter.
2. Connect the other end to the Main Unit.

#### Important

- Please make sure that the 4mm hose is secured with a zip ties after the installation to prevent them from disconnecting.
- The supplied filter must be installed.
- Make sure that the filter is installed in the correct direction.
- If the filter is dirty or clogged, replace it with a new one. A dirty filter can affect the unit's performance.

### Installation Diagram

Diagram 1: Vehicle with factory boost controlling solenoid valve  
Dual Port Actuator

Disconnect the connector and the vacuum lines off from the solenoid valve and plug up the all the vacuum ports.

Before

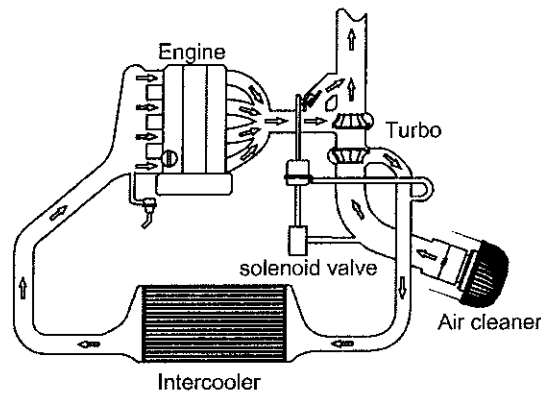

After

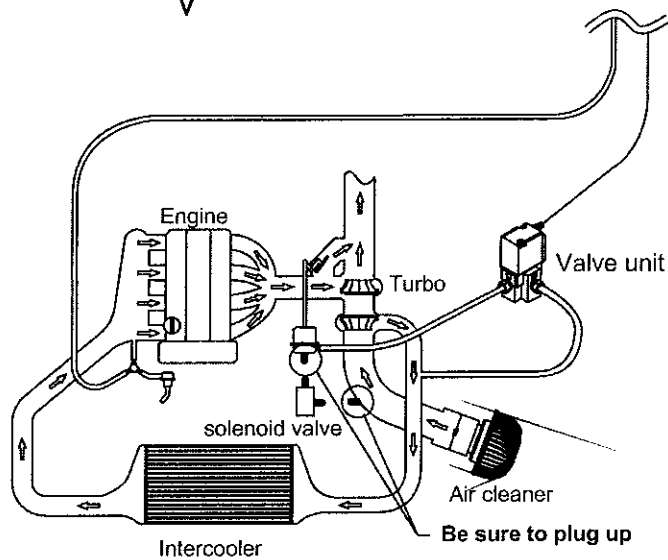



**Product Features**

**Diagram 2: Vehicle with factory boost controlling solenoid valve  
Single port actuator**

Disconnect the connector and the vacuum lines off from the solenoid valve and plug up the all the vacuum ports.

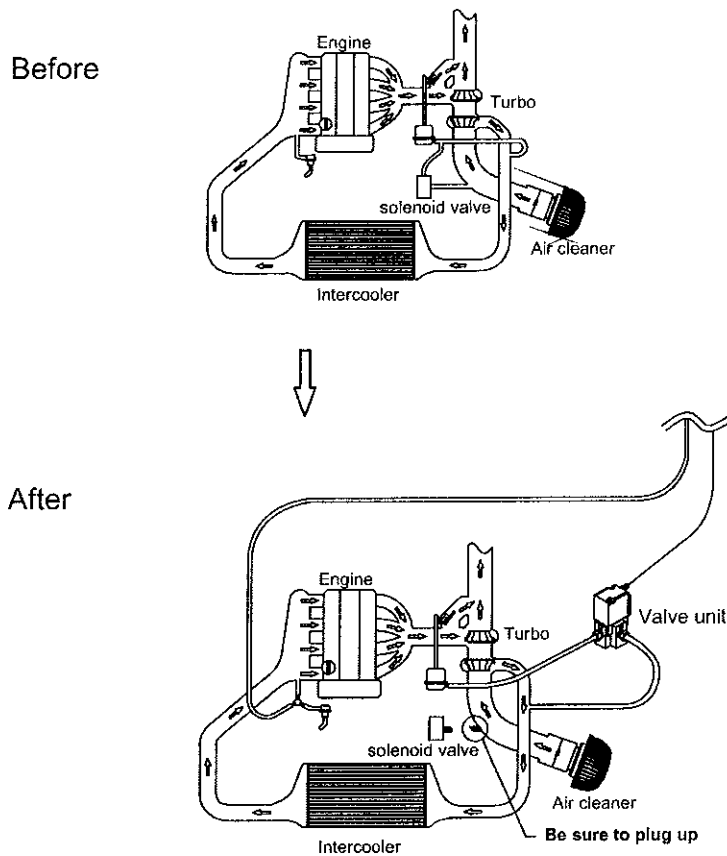

### Valve Unit Installation (Actuator Type)

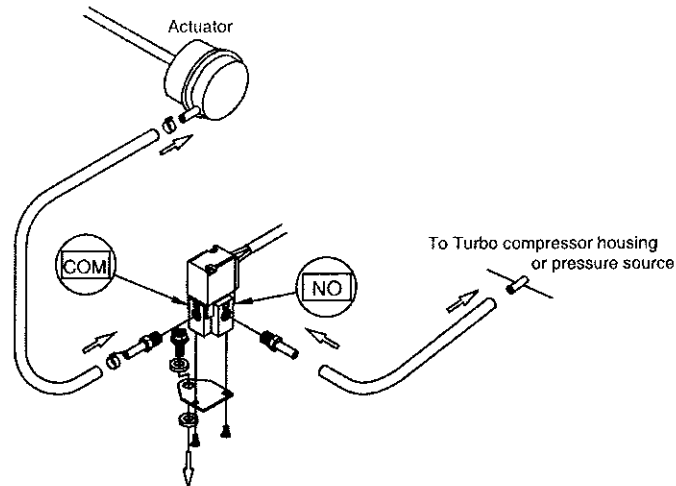

- (1) Remove ALL the plastic plugs from the Valve unit
- (2) Install the 6mm Hose fitting on to "NO" and "COM" port on the Valve unit.
- (3) Install the Valve bracket using the supplied M4 bolts. Then, secure the Valve assembly to the body using the supplied M6 Bolt and Rubber washer.
- (4) Disconnect the vacuum hose connecting the compressor housing of the turbo to the actuator at the actuator side and connect it to the "NO" side of the Valve unit.
- (5) Connect the "COM" port to the actuator using the supplied 6mm vacuum hose.

#### **Important!**

- It is very important that the Rubber washer is used when mounting the bracket to the body.
- Mount the Valve unit in a cool area where the unit will not get hot or wet.
- Secure all the Vacuum connections with hose clamps.
- When routing the vacuum hoses, make sure not to kink or twist the hoses.
- Make the hoses as short as possible.
- It is normal for the Valve unit to make a clicking sound when it is operating.

### Valve Unit Installation (External Wastegate Type)

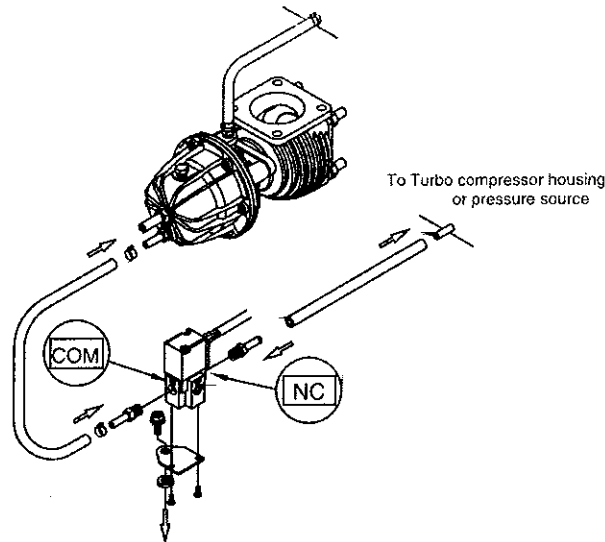

- (1) Install the 6mm Hose fitting onto "NC" and "COM" port on the Valve unit.
- (2) Install the Valve bracket using the supplied M4 Bolts. Then, secure the Valve assembly to the body using the supplied M6 Bolt and Rubber washer.
- (3) Install a 6mm Hose fitting (sold separately) on the top of the wastegate.
- (4) Connect the 6mm Hose fitting that was just installed to the "COM" port of the valve unit using the supplied 6mm vacuum hose.
- (5) Connect the "NC" port to a good pressure source such as the Compressor housing of the turbo using the supplied 6mm Vacuum hose. (It is ok to tap into the same line that is going to the bottom port on he wastegate)

#### Important!

- It is very important that the Rubber washer is used when mounting the bracket to the body.
- Mount the Valve unit in a cool area where the unit will not get hot or wet.
- It is normal for the Valve unit to make a clicking sound when it is operating.

## Wiring Procedures

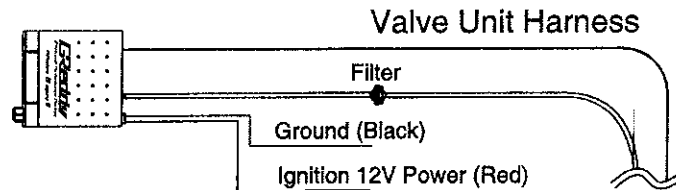

- (1) Connect the Valve unit harness to the Valve unit that was installed in the engine compartment.
- (2) Route the Valve unit harness through the firewall in to the passenger compartment and connect them to the main unit.
- (3) Reconnect the battery and find 12V Ignition source with a tester.
- (4) Disconnect the negative terminal of the battery and connect the 12V ignition source to the power harness. (red wire)
- (5) Ground the black wire to the body. When grounding to the body, sand or grind off any paint or rust to ensure good contact.

## Wiring Procedures

- (1) Mount the Main Unit to a desired location using the provided double sided tape



### Warning



When mounting this product in the vehicle, be sure the unit does not interfere with the driver's view and normal operation of the vehicle.

### Please

- Make sure that the area where the main unit going to mount is free of dirt and oil. Wipe the area clean.

## **Installation inspection**

**Please read**

- Reinstall all the parts that were removed during the installation of this product.
- Reconnect the negative terminal of the battery.
- Make sure that all harnesses and hoses are secured, properly connected and routed.
- Improper connection and routing of the harnesses and hoses can damage the unit and the sensors, which can cause engine damage.
- TRUST Co. Ltd. and GReddy Performance Products, Inc. is not responsible for any engine damage caused by improper installation.

## **How to use with Switching Harness (sold separately)**

- To connect to the GReddy Speed Limiter Cut Controller Type-A

The HI/LO mode can be switched at desired vehicle speed.

### **Wiring procedure**

1. Connect the WHITE wire on the Switching Harness to the YELLOW wire (option output wire) of the GReddy Speed Limiter Cut Controller.
2. Connect the BLACK wire on the Switching Harness to the BLACK wire (ground wire) of the GReddy Speed Limiter Cut Controller
3. Turn the #4 dip switch in the GReddy Speed Limiter Cut Controller on.
4. With the Main Unit turned off, connect the GReddy Speed Limiter Cut Controller jack in to the Option port of the main unit.
5. Set the desired speed to switch the HI/LO mode. Refer to the GReddy Speed Limiter Cut Controller manual.

## Controller Functions

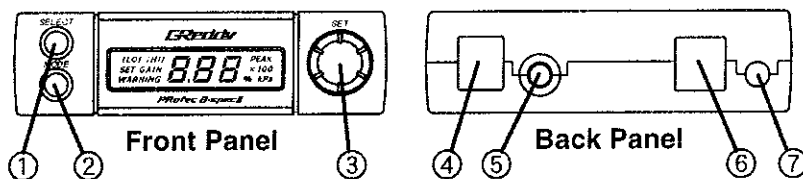

### <Front Panel>

1. SELECT switch
  - Press once ----- to switch the boost mode (HI/LO)
  - Hold down for 2 sec ----- to turn the boost controller OFF.  
Repeat to turn it back ON.
2. MODE switch
  - Press once ----- to scroll through different modes.  
to cancel out while in the setup mode.
3. SET knob
  - Turn ----- to change value.
  - Press ----- to confirm the changed value.

### <Back Panel>

4. Power Harness connector
5. 4mm pressure port
6. Vale Unit Harness connector
7. Option
  - used for Remote Switching System or Switching Harness  
(sold separately)

### **Changing Boost Mode**

- To change the HI/LO boost mode, press the SELECT switch once.

This unit will allow the user to set the SET BOOST, GAIN, START BOOST, WARNING, and LIMITER for each of the HI and LO boost mode.

- To turn the boost controller OFF, hold down the SELECT switch for 2 sec.

The display will still show the base boost (stock boost) in real time. The display will also show the PEAK and LAST BOOST.

#### **Important**

- On a vehicle that was equipped with a stock boost controlling solenoid valve, by removing this unit, the base boost (stock boost) will be lower than before with the stock boost controlling solenoid valve.
- Base boost (stock boost) will vary with different vehicles and applications.
- This unit is not able to lower the boost lower than the base boost.

### **Changing Pressure Unit**

The pressure unit is preset at the factory to read and display kPa pressure, but it can be changed psi pressure.

$$100\text{kPa} = 1.01972\text{kg/cm}^2 = 14.5\text{psi}$$

How to change pressure unit

1. At OFF mode, hold down SELECT button, and with in 2 sec. press the MODE button 2 times. Repeat this procedure to go back to previous setting.

\*When psi is displayed, it will show psi in x10 value.

$\frac{\times 100}{\% \text{ kPa}}$  in the right bottom corner will disappear.

14.5psi will display 145

10.0psi will display 100

Mode Flow Chart

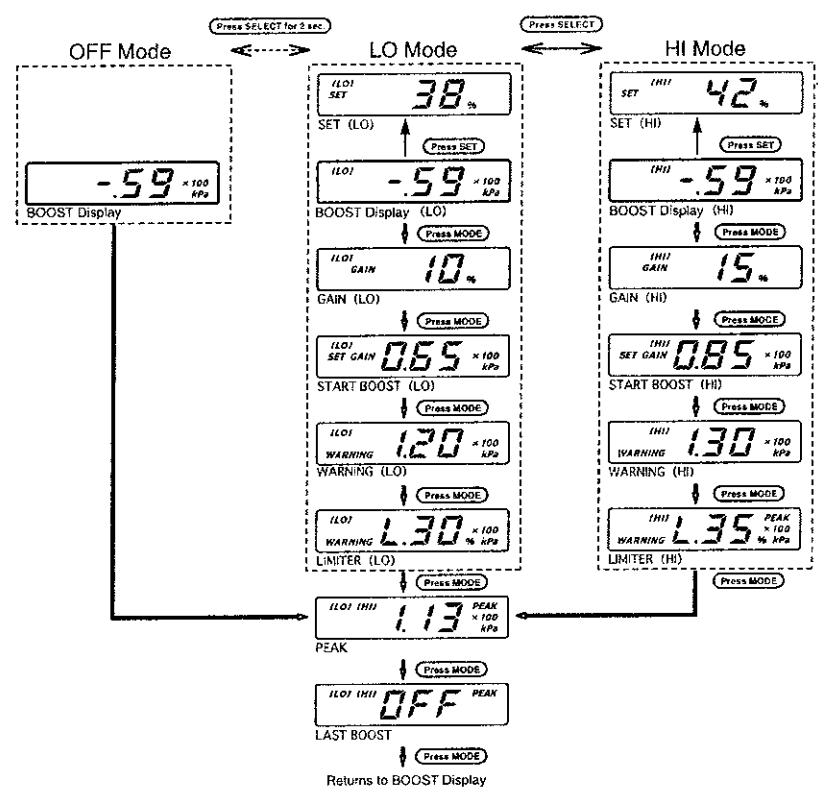

■ The pressure shown in the flow chart above is in kPa. To change the unit to psi, see "Changing Pressure Unit" on page 14.



## SET

This mode is used to set the desired boost pressure.

The % set in this mode is not the actual boost pressure.

This feature controls the duty rate of the Valve Unit which controls the boost.

- Raise the % to increase the boost, and lower % to decrease the boost.
- 100% setting will boost up to the turbocharger/wastegate's limit.
- 0% will boost the base boost (stock boost).

How to adjust

1. While in Boost display, turn the Set knob to show the current SET setting and continue to turn the knob to the desired SET value.
  - \* While in SET mode, the SET value will flash.
  - \* If the MODE switch is pressed while in the SET mode, it will cancel out of SET mode and go back to previous setting.
2. Press the SET knob to confirm the setting. The SET value will stop flashing and return to Boost display.
  - \* Monitor the boost as you increase the setting.

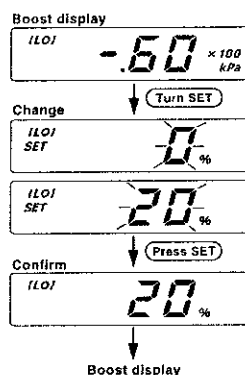

## GAIN

This mode is used to adjust the boost consistency.

(Adjusts the sensitivity of the valve control.)

- When boost spike occurs, lower the GAIN value.
- When the boost falls off at high rpm, or the boost increases as rpm increases, raise the GAIN value.
- Even if the SET boost is not changed, by increasing the GAIN value, it will increase the boost.

How to adjust

1. While in Boost display, press the Set knob once to show the current Gain setting.
  - \* it will return to boost display mode after 4 sec.
2. Within 4 sec, turn the knob to the desired Gain value.
  - \* If the MODE switch is pressed while in the SET mode, it will cancel out of SET mode and go back to previous setting.
3. Press the SET knob to confirm the setting. The GAIN value will stop flashing and return to Boost display.

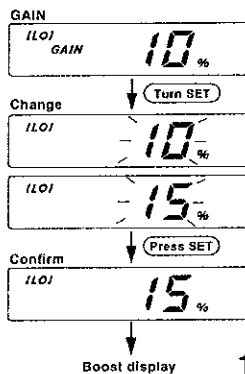

## START BOOST

This mode is used to adjust the boost response.

This feature basically adjusts when to start opening the wastegate.

- If the START Boost value is closer to the SET boost value, the spool up will be faster.
- If it is too close to the SET boost, it will cause the boost to spike.

How to adjust

1. While in Boost display, press the Set knob 2 times to show the current START BOOST setting.
  - \* START BOOST mode is indicated by SET and GAIN in the display.
  - \* it will return to boost display mode after 4 sec.
2. With in 4 sec, turn the knob to the desired START BOOST value.  
(range:0~3.00 x 100kPa)
  - \* If the MODE switch is pressed while in the START BOOST mode, it will cancel out and return back to pervious setting.
3. Press the SET knob to confirm the setting. The SET value will stop flashing and return to Boost display.
  - \*Until the setting is confirmed, the display will not return to boost display.

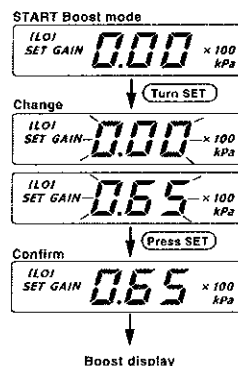

### Important

- Make sure to monitor the boost while adjusting SET, GAIN, and START BOOST setting.
- This boost controller will not control over the capacity of the turbocharger and wastegate limit.
- It is very important that the user find out the maximum boost limit of the engine and turbocharger before increasing the boost. Do not over work the turbo.

## WARNING

This mode is used to adjust the WARNING Setting. An alarm will sound when boost reaches the warning setting.

- Set to the maximum boost level you do not want to exceed.

How to adjust

1. While in Boost display, press the Set knob 3 times to show the current WARNING setting.  
\* it will return to boost display mode after 4 sec.
2. With in 4 sec, turn the knob to the desired WARNING value.  
\* If the MODE switch is pressed while in the WARNING mode, it will cancel out and go back to pervious setting.
2. Press the SET knob to confirm the setting. The WARNING value will stop flashing and return to Boost display.

WARNING display (red back light & "WARNING" is displayed)

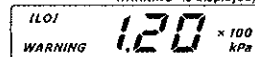

Change (Turn SET)

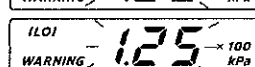
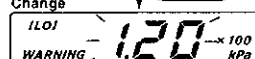

Confirm (Press SET)

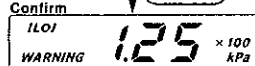

Boost display

## LIMITER

This mode is used to adjust LIMITER to lower the boost when the boost exceeds the WARNING setting. (This will lower the entered % from of the SET boost valve duty rate to lower the boost)

- 99% will turn off any boost control. (back to stock boost)
- 0% will disable the LIMITER feature.

How to adjust

1. While in Boost display, press the Set knob 4 times to show the current LIMITER setting.  
\* it will return to boost display mode after 4 sec.
2. With in 4 sec, turn the knob to the desired LIMITER % value.  
\* If the MODE switch is pressed while in the LIMITER mode, it will cancel out of SET mode and go back to pervious setting.
3. Press the SET knob to confirm the setting. The LIMITER value will stop flashing and return to Boost display.

LIMITER display (red back light & "WARNING" and "L" is displayed)

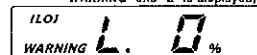

Change (Turn SET)

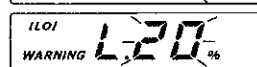
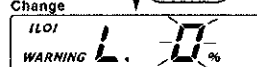

Confirm (Press SET)

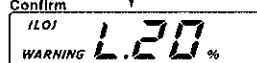

Boost display

## PEAK

This mode is used to display the PEAK boost recorded.  
Recorded peak value will not be cleared even if the battery is disconnected.

How to clear the PEAK value

1. While in Boost display, press the SET knob 5 times to show the current PEAK boost recorded.  
\* it will return to boost display mode after 4 sec.
2. With in 4 sec, press the SET knob for 1 sec to clear the recorded PEAK boost, then it will return to boost display.

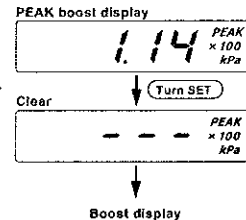

## LAST BOOST

This mode is used to display the last boost that was recorded every time the accelerator was released for 3 sec.

How to turn this feature ON and OFF.

1. While in Boost display, press the SET knob 6 times to show the current LAST BOOST setting.  
\* it will return to boost display mode after 4 sec.
2. With in 4 sec, turn the SET knob to turn ON or OFF.  
\* If the MODE switch is pressed while in the this mode, it will cancel out and return back to pervious setting.
3. Press the SET knob to confirm the setting and it will return to Boost display.

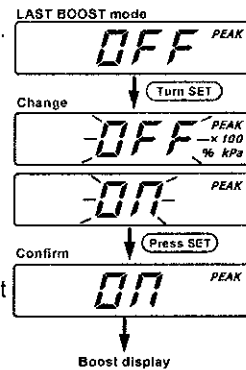

### Factory Setting

Boost Mode ----- LO  
SET ----- 0 (%)  
GAIN ----- 10 (%)  
START BOOST ----- 0 (x100kPa)  
WARNING ----- 1.20 (x100kPa)  
LIMITER ----- 0 (%)  
PEAK ----- 0 (x100kPa)  
LAST BOOST ----- ON

### Boost Setting tips

1. Monitor the boost display to set the SET boost closest to the desired boost pressure.
  - \* Turn the LAST BOOST feature ON and monitor the last boost that was recorded to help achieve the desired boost pressure.
2. When boost spike occurs, lower the GAIN adjustment 2 increments at a time until it stabilizes.  
If the Boost falls off at higher rpm, increase the GAIN adjustment 2 increments at a time until it stabilizes.  
(On certain applications, it is possible that the boost pressure will not stabilize due to the engine and the turbocharger/wastegate characteristics.)
3. When the boost pressure stabilizes, go back to SET boost mode and adjust the boost to the desired boost pressure.
4. To improve the boost response, adjust the START BOOST value closer to the SET boost pressure.
  - \* Adjusting the START BOOST too close to the SET boost pressure, it will cause boost spike. Try to get it set right before the boost spike occur. This will be the best response possible for the application.

### Trouble shooting

Problem description	Possible Cause	Solution
1. Boost will not increase. Boost will continue to increase.	- Not receiving intake manifold pressure.	- Check the pressure hose connection to the intake.
	- Valve Unit connector is disconnected.	- Check the Valve Unit connector.
	- The hose fitting on the Valve Unit is installed improperly. - Pressure hoses are installed improperly. - Pressure hoses are disconnected. - Plug is not removed on the Valve Unit.	- Check the hose fitting and the pressure hose on the Valve Unit. - The hose fitting should be installed in NO port for Actuator type and NC for external wastegate.
2. Inconsistent boost. Boosts up and down.	- GAIN is set too high.	- Lower the GAIN setting.
3. Bad response.	- START BOOST is set to 0.	- Increase the START BOOST setting.
4. Boost spike occurs.	- GAIN setting is not adjusted for the vehicle's application.	- Adjust the GAIN setting.
	- START BOOST is set too high.	- Lower the START BOOST setting.
5. Boost fall off or continue to raise at higher rpm.	- GAIN is set too low.	- Increase the GAIN setting.
	- Trying to boost over the turbocharger's capacity, and/or due to wastegate's characteristic. Too much exhaust pressure.	- Need to upgrade the turbo, and/or wastegate setup to handle the desired boost.

### **Option Parts, Replacement Parts**

Option parts for Profec B-spec 2

Product	Price
- Switch Harness	\$12.00
- Remote Switching System	\$128.00

Replacement parts for Profec B-spec 2

- Air filter
- Valve Unit
- Valve Unit Harness

\* to purchase these items, please contact your Trust or GReddy authorized dealer where the Profec B-spec 2 was purchased.

### **about Customer Service**

- If there are any questions or concerns regarding this product, please contact you dealer or TRUST/GReddy.
- This product is covered by 1 year warranty from time of purchase towards any manufacture defects. Please check your warranty policy of our product with your TRUST/GReddy authorized dealer as our warranty policy vary in different counties.

TRUST Co. Ltd.  
3115 Odai, Sanbugun  
Shibayama-machi, Chiba  
289-1605 Japan.  
Tel. 0479 (77)3000

GReddy Performance Products, Inc.  
9 Vanderbilt.  
Irvine, CA 92618 USA  
Tel. (949) 588-8300