

6000 WARNING METER







Installation Manual

Notes:

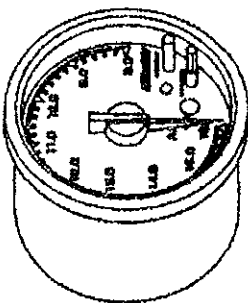
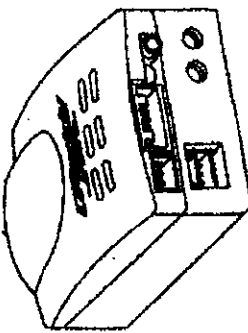
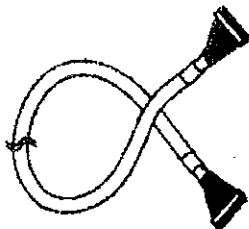
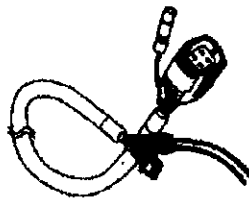
Lined area for notes.

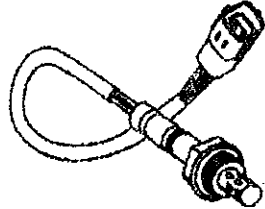
1. Parts List

-  A / F Gauge
1pc.
-  Data Link Unit
1pc.
-  Gauge Harness
1pc.
-  Sensor Harness
1pc.
-  Power Harness
1pc.
-  A / F Sensor
1pc.
-  ECU Connection Harness

1. Parts List

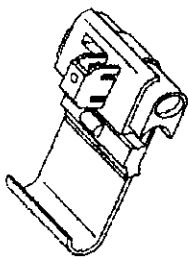

Wire Tap
5 pcs.

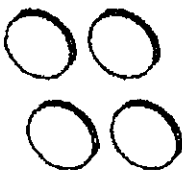

Double Sided Tape
1 set

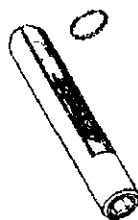

Warning Key
1 pc.

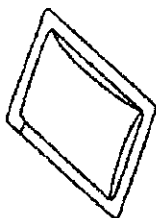

Cleaner Pad
1 pc.



Harness Labels
1 set



Instruction Manual
1 pc.

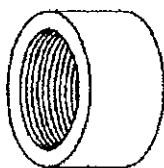

Sensor Mount
1 pc.



Wire Tie
4 pcs.

Notes:

Blank lined area for notes.

3. Operation Method:

Sensor - Vehicle Adjustment

After the wiring is complete, turn on the ignition power, and press hold the SELECT switch on the Data Link Unit for 2 seconds.

Then use the SELECT switch to toggle from the four different adjustments, described below:

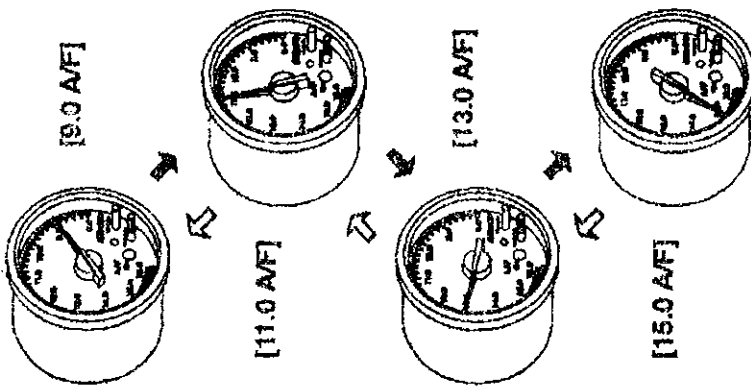

- The unit comes preset for 9.0
- If the outside temperature is below 15° C or 59° F, you should start with the setting 13.0 or 15.0
- Because the exhaust temperature will vary according to the vehicle's specifications and conditions (level of modifications, race vehicle, high boost & exhaust pressure, and high RPM range) you may have to try different setting to achieve a steady needle motion.
- Until you brake-in the sensor the needle movement may be unstable.

Conditions for the Sensor	Setting	Example
① The O ₂ sensor is mounted in the factory location and has high exhaust pressure.	[9.0 A/F]	Vehicles with high EGT. (Turbo & 4WD vehicles)
② The O ₂ sensor is mounted farther away than the factory location and has high exhaust pressure.	[11.0 A/F]	Vehicles with lower EGT than ①. (Turbo & 4WD)
③ The O ₂ sensor is mounted in the factory location and has low exhaust pressure.	[13.0 A/F]	Vehicles with lower EGT than ① (Non-Turbo & 2WD)
④ The O ₂ sensor is mounted farther away than the factory location and has low exhaust pressure.	[15.0 A/F]	Vehicles with lower EGT than ③ (Non-Turbo & 2WD)

3. Operation Method:

Meter Operation

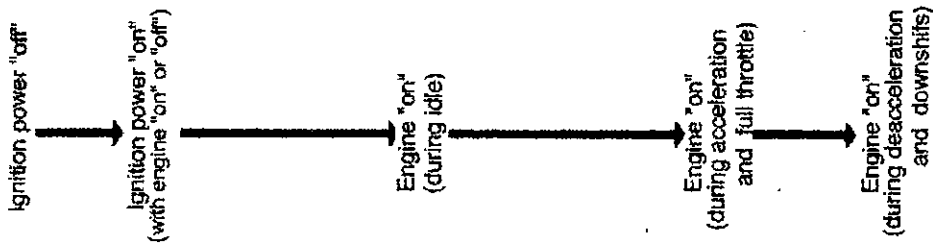

- (1) The needle points to 16.0 A/F and the LED is not lit.
- (2) During cold starts, the sensor is not warmed up yet, the "Bad Connection Check Function" will activate, but as the sensor warms up it will change to the normal "Warm Up Mode."
 - For details about the "Warm Up Mode" see page:
- (3) After the "Warm Up Mode" is over, (the gauge will show the current A/F ratio) the needle should point to a value close to 14.6 A/F during idle.
 - There will be some vehicles that will be pointing closer to 8.0 A/F
- (4) When the needle moves below the 14.6 A/F (towards 8.0 A/F) it is showing a richer reading.
 - The A/F ratio will vary according to the way the vehicle is set up.
- (5) When the needle moves above the 14.6 A/F (towards 16.0 A/F) it is showing a leaner reading.
 - Under hard deceleration, when down shifting the unit may activate the "Short Circuit Function", but as soon as you begin to accel again, the check lamp should turn "off"

You can purchase this part at: <http://thmotorsports.com>

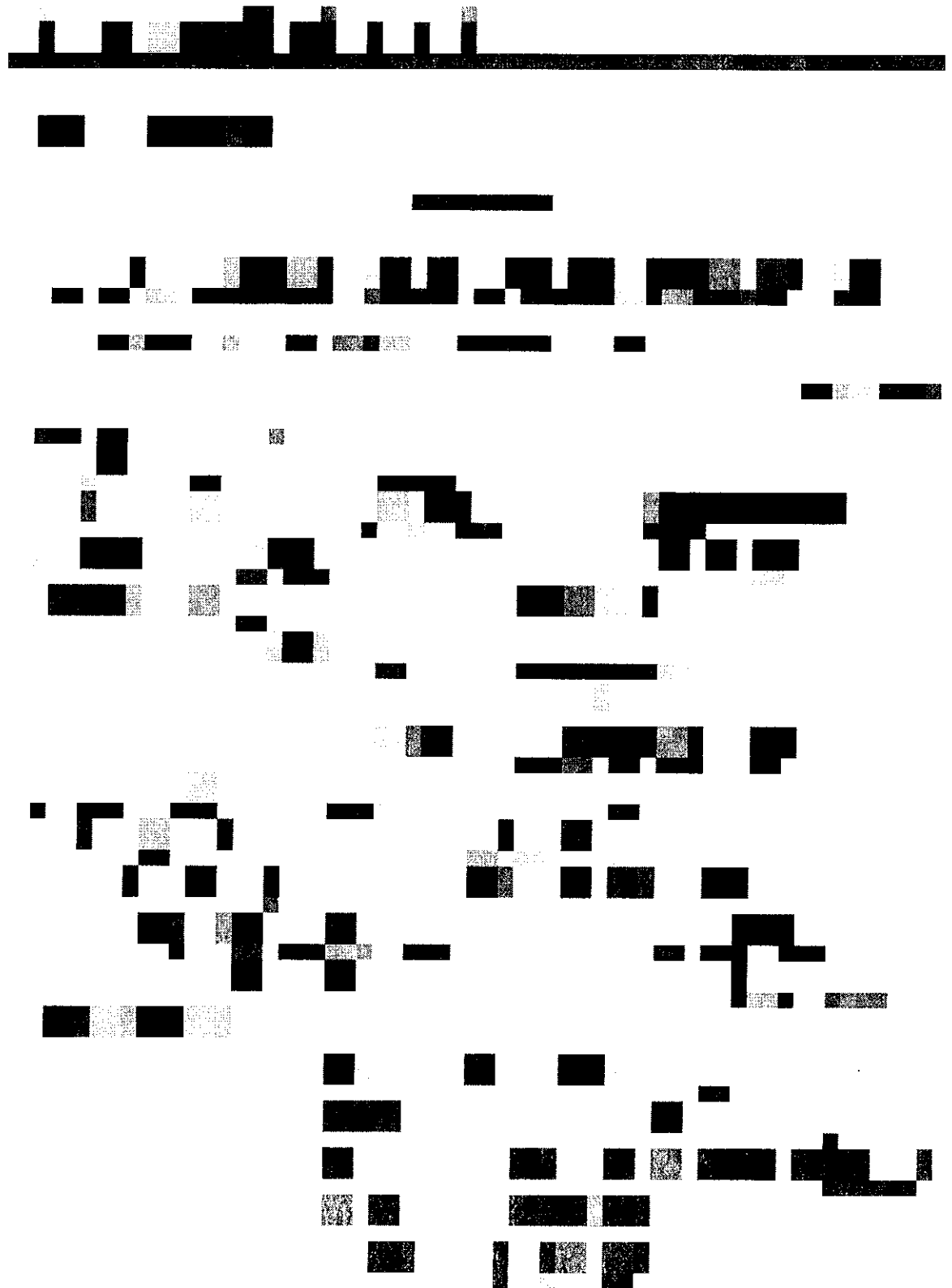

More installation manuals at: www.thmotorsports.net

2. Installation Method:

(1) Installation, while replacing the factory O₂ sensor .

1-1 Sensor Installation (in the factory location)

Replacing the factory sensor will require using the GREEN wire - output to the ECU

Caution !

Be sure to install and route the sensor and sensor harness away from any ignition devices, that may produce interference to electrical components. This can cause malfunctions in the unit.

When installing the sensor and sensor harness, be sure to install the sensor before connection it to the sensor harness. Do not over twist the wires.

Be sure to install the O₂ sensor where it will not get wet.

Be aware not to route the sensor harness too close or in direct contact with the exhaust pipes.

If you are replacing the factory O₂ sensor, be sure to tape up the electrical connector with electrical tape and store the factory sensor in a safe place.

Be aware that if the A/F gauge is not powered up the ECU will not receive signals from the O₂ sensor.

There are cases where, the factory O₂ sensor can not be replaced with the provided O₂ sensor. On some lean burning engines, the signal may not be compatible with the ECU. In these cases you must install the provided O₂ sensor in another location. (see page 7)

2. Installation Method:

- (1) Installation, while retaining the factory O² sensor .
1-1 Sensor installation (in the factory location)
Replacing the factory sensor will require using the GREEN wire - output to the ECU

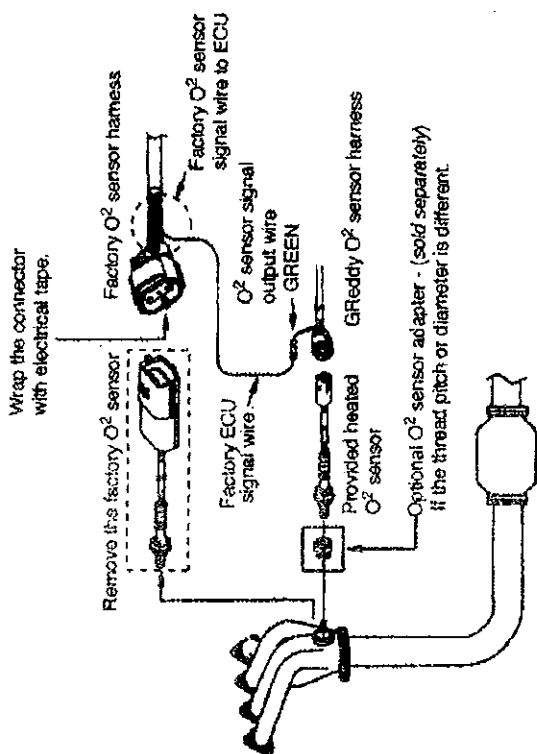

Caution!

Do not make mistakes in the wiring of this unit. Miswiring can cause damage to both the unit and the electronic devices of the vehicle.

4. Maintenance Method:

Replacing the Illumination Bulbs.

If the illumination bulb goes out, you can purchase replacement bulbs from your favorite Authorized GReddy Dealer and replace them by following the directions below.

Removing the Bulb

1. Disconnect the negative terminal of the battery
2. Remove the gauge from the vehicle.
3. Remove the illumination bulb caps on the rear of the gauge.
(be careful not to damage the caps because they will be reused)
4. Using the appropriate screwdriver, unscrew the bulb 45o counter-clockwise and remove the bulb.
(please be careful not to damage the bulb lock and circuit board)

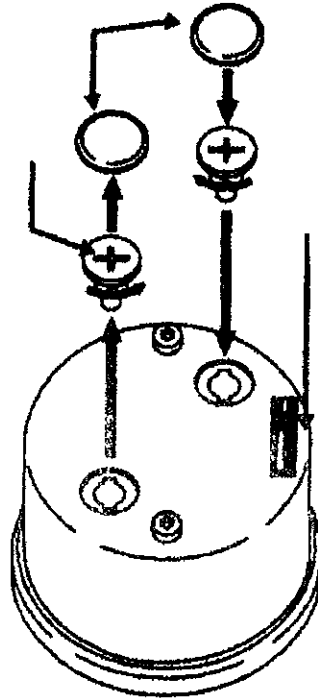

Installing the Bulb

5. Reverse steps 1.-4. in Removing the Bulb.
(make sure the bulb caps are reinstalled to prevent the unit from short circuiting.)

2. Installation Method:

Finding the vehicle's O² sensor signal wires.
(If using the the GReddy AF sensor in the factory location)

Method 1.

With the engine "on" and the O² sensor connected, use a multimeter to check for a wire that shows a change in voltage from 0-1 volts when you rev the engine to 3000 RPM. This will be the O² sensor signal wire

Method 2.

Sensor harness with 1 wire: (sensor signal wire)
if it has a single wire, then that will be the signal wire.

Sensor harness with 2 wires: (sensor signal wire, sensor ground wire)
Disconnect the factory O² sensor harness. Then use a multimeter to test the vehicle harness side of the connector. **The wire with no current going through the wire is the sensor signal wire**, the wire with the current will be the sensor ground wire.

Sensor harness with 3 wires: (sensor signal wire, heater 12v, heater ground)
Disconnect the factory O² sensor harness. Use a multimeter to test the vehicle harness side of the connector. The wire with 12v when the ignition is on is the heater. From the remaining 2 wires, **the wire with no current going through the wire is the sensor signal wire**, the wire with the current will be the heater ground wire.

Sensor harness with 4 wires: (sensor signal wire, sensor ground wire, heater 12v, heater ground)

Disconnect the factory O² sensor harness. Use a multimeter to test the vehicle harness side of the connector. The wire with 12v when the ignition is on is the heater. From the remaining 3 wires, **the wire with no current going through the wire is the sensor signal wire**.

2. Installation Method:

- (1) Installation, while retaining the factory O² sensor .
- 1-2 Installing the sensor
- if the factory O² sensor is used, you must install the A/F sensor in a new location.

Important!

When making a hole in an exhaust pipe, that is still attached to the engine, be careful not let debris into the piping.

Try to locate a position where the sensor will receive a temperature range between 400-800 degrees Celsius. (Ideally, the temperature range should be between 500-700degrees).

(The GREEN wire for ECU signal will not be used in this case!)

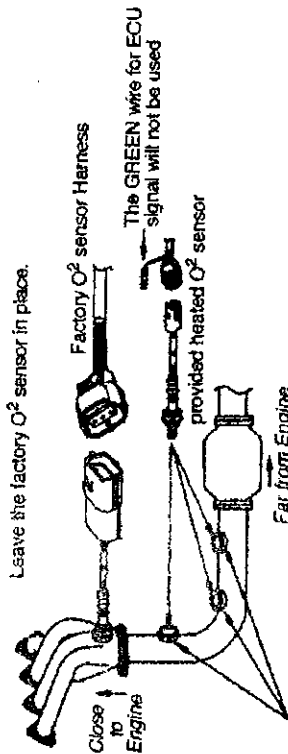

The best way to find a good location for the O² sensor is to check where the EGT sensor is and what temperature range does it usually display. Then you can appropriately chose a good location for the provided heated O² sensor. (hotter - closer to the engine, colder -farther from the engine)

if the O² sensor is located too far from the engine, the O² sensor's temperature will not function properly and may cause malfunctions in the unit.

3. Operation Method:

- (3) Check Function Instructions .

Wire Failure Check Function

This function is to alert the user when there is a loose connection, loose wire or missing wiring of the sensor or sensor harness.

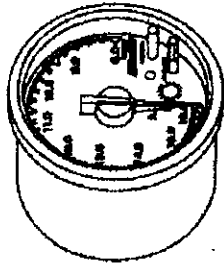

When there is a wire failure, the needle will point straight down at the 16.0 and the Warning LED will flash a pattern of 2 blinks. (Blink, Blink -- Blink, Blink . . .)

The unit will not function at all if the power harness has a failure.

Short Circuit Check Function

This function is to alert the user when there is a short circuit on the sensor or sensor harness.

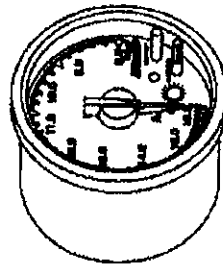

When there is a short circuit, the needle will point straight down at the 16.0 and the Warning LED will flash continuously (Blink, Blink, Blink, Blink . . .)

The unit will not function at all if the power harness has a failure.

3. Operation Method:

Correction Mode

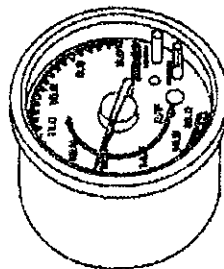
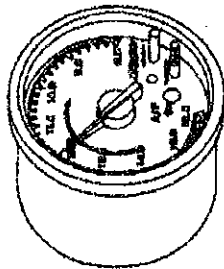

This mode will normally not be used. This mode is to only be used to adjust the gauge with a professional, laboratory spec. A/F monitor. These units are very expensive and accurate.

If there is a large difference in the GReddy A/F gauge and the professional unit, it can be corrected with this mode.

- **Correction Method:**
By slightly turning the "Calibration-Adjustment Knob" on the Data Link Unit, the gauge will go into "Correction Mode"
- The Zero point will be 12.0, by turning the knob Clock-wise will cause the gauge to read "Richer" and Counter-Clock-wise will read "Leaner."
- The range is from 10.0 to 14.0, so there is a 2.0 range (in 0.1 increments), 10 seconds after the last correction of the knob, the unit will return to "Real Mode"

2. Installation Method:

(2) Data Link Harness Connections

Warning!

Please be aware of the lengths of the wiring harnesses and make sure the unit does not interfere with driving the vehicle, when finding a suitable mounting location.

Important!

Be sure to use wire ties to secure the harness so they do not interfere with driving.

1-2 Data link diagram:

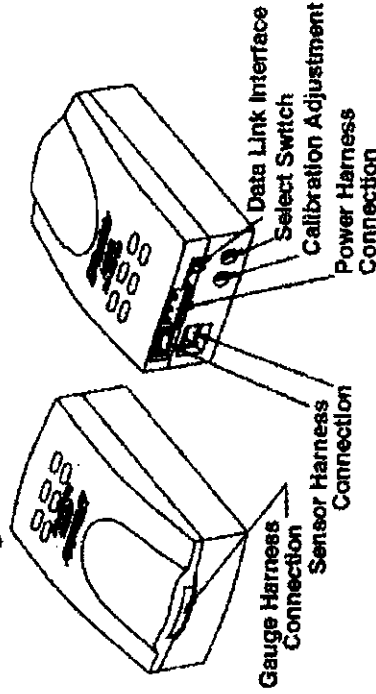

Select Switch:

Used to choose from the 4 selections. This will depend on the exhaust gas temprature, exhaust pressure, and other specifications. (see page)

Calibration Adjustment:

Not used on normal operation. (this can be used to calibrate the unit with a professional laboratory spec. A/F meter.)

Data Link Interface:

Used to connect this gauge to the GReddy Gradis 9000 data logger

2. Installation Method:

Caution!

Before beginning the installation, disconnect the negative terminal of the battery.
 Be sure to connect all harness connectors properly. Loose connectors may cause malfunctions.
 Be sure to connect the RED constant 12v source to a separate source than the ORANGE Ignition 12v source.
 Not supplying a constant 12v source may lead to malfunctions.

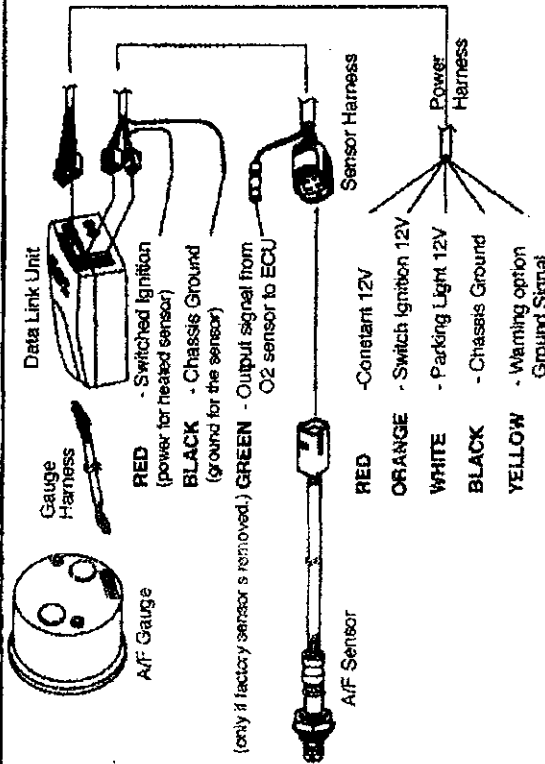

3. Operation Method:

Sensor Over Heat Mode

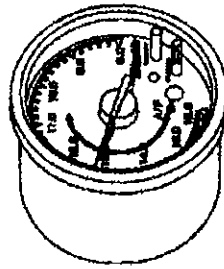
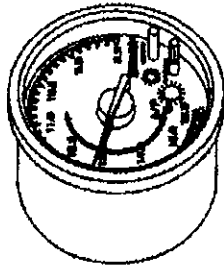

- While in Real Time Mode, if the Memory LED and Warning LED begin to flash alternately, the unit is in Sensor Over Heat Mode.
 - If this occurs the reading the unit shows will not be accurate, in order to get out of this mode, the vehicle should be driven at a lower exhaust pressure and RPM, or even stopped and allowed to idle.
 - When the Memory LED and Warning LED stop flashing, the unit has returned to Real Time Mode.
 - For race cars produce high boost pressure and high RPM, should install the O2 sensor farther away from the engine to prevent the sensor from overheating.
- Continuous Over heating of the unit will shorten the life of the sensor and damage internal compenents of the sensor.**

3. Operation Method:

Set Warning Mode

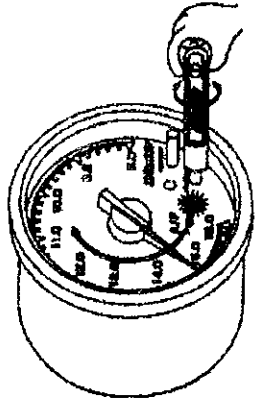

- To set the Warning point, use the provided socket, to slightly turn the Warning Switch. The Warning LED will illuminate and the gauge will now be in Set Warning Mode.
- Turn the Warning Switch to move the needle to the desired warning point. Then 5 seconds after the last adjustment, the unit will return to Real Time Mode.

Warning Mode

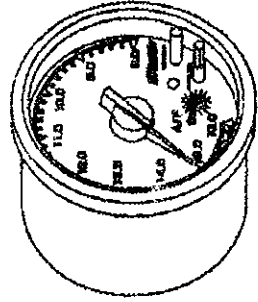

- The warning is for a rich value. Whenever the needle falls below the warning point (*reads too lean*) the Warning LED will illuminate. When the Warning LED illuminates, it also provides a negative signal to the YELLOW wire on the power harness. (this is can be use for a optional external warning light, buzzer or etc.) As the needle raises above the warning point, the Warning LEI will go out.

2. Installation Method:

Soldering Wires

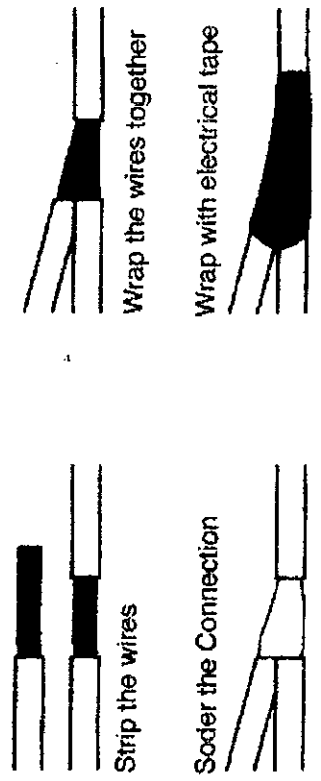

Wire Taps

Place the source wire to in the edge rail of the connector, then place the other wire in the rail with the stoper.



Press the clip all the way down into both of the wires.

Lock the cover hook over the clip.

Important!

When connecting wire, make sure all the connections are secure and good conductivity.

2. Installation Method:

Warning!

Before installation of the gauge portion of the unit, make sure the mounting location does not interfere with driving the vehicle. Also make sure the unit is mounted so it will not fall and get damaged.

Note !

When mounting the gauge on the dash or A-pillar, you should use the optional GReddy gauge holder - (sold separately).

Caution!

When mounting the gauge always mount it horizontally or pointing upwards. If the gauge is mounted with the face pointing downward the gauge will malfunction.

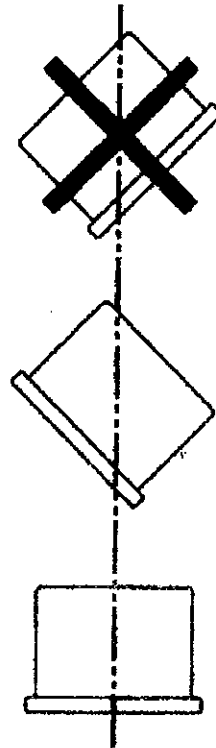

Be sure to neatly secure all harnesses so they do not interfere with driving.

3. Operation Method:

**Peak Hold Mode
(Richest Value)**

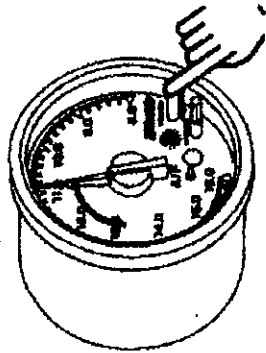

When in Real Time Mode, if you depress the Memory Switch for, over 2 seconds, it will cause the Memory LED to stay illuminated and whatever is the peak (rich) value that is achieved will remain on.

The LED will continue to stay lit and the needle will show the peak value until you either press the Memory Switch once (resets the peak value and stays in "Peak Mode") or you hold the Memory Switch for over 2 seconds and the unit returns to "Real Mode". The peak values are never stored in memory once you change the mode it is erased.

3. Operation Method:

Real Time Mode

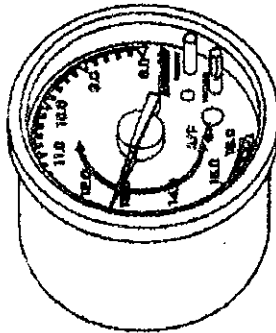

The needle will show the current A/F reading.

(be sure to break-in the sensor)

Hold Mode

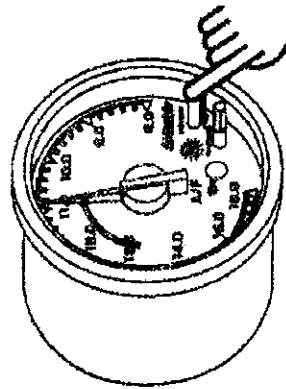

When in Real Time Mode, if you depress the Memory Switch once, it will cause the Memory LED to blink and "hold" (or freeze) that value. The LED will continue to flash and the needle will hold that value until you once again press the Memory Switch. Then it will return to Real Time Mode. (the unit will not save this value in its memory)

2. Installation Method:

(4) Final inspection:

Please double-check to see that all the hose connections are correct. Make sure there is no miss wiring or leaks.

Check that the sensor and harnesses do no touch or rub up against any moving devices. (radiator fan, throttle body, etc.)

Check that the sensor and harnesses are routed away from any ignition devices. (ignition coils, distributor, or plug wires)

Check that the gauge, data link, or harnesses are mount so that they do not interfere with driving the vehicle.

Check that any interior panels or electrical connections that were removed are reinstalled in there proper position.

Warning!

After installation, please check to see that all tools are removed from both the engine compartment and interior, that might interfere with safe driving.

Reconnect the negative terminal of the battery tightly and close the hood.

This concludes the installation procedure.

3. Operation Method:

(1) Before using . . .

Please read the "Notice" and "Example" below, to fully understand the operation of this unit.

Notice !

This unit will be monitoring the air/fuel ratio from the vehicle's exhaust gas in various situations. Even though this unit's O₂ sensor is equipped with a high-performance heater, the sensor's structure and specifications differ from professional laboratory spec. air/fuel monitors that can measure the correct air/fuel ratio. When the exhaust gas temperature and the sensor temperature changes, the gauge's air/fuel ratio reading will also change. Even if it is adjusted with the "Correction Mode," it may still differ from the actual correct ratio reading. This is why, **it is not recommended to do actual fuel setting using only this unit.** This gauge is meant to be used to monitor the average ratio differences in climate, atmospheric pressure, and before and after for fuel setting. This unit can also be used to monitor any changes in the air/fuel ratio in order to avoid any trouble. GReddy Performance Products, Inc. will not be held

Example:

An authorized GReddy dealer used a professional air/fuel monitor unit to set-up the fuel system in the customer's vehicle. Then returned the vehicle to the customer after the dealer set the air/fuel ratio on the unit during the full throttle using the "Correction Mode"

After the fuel setting was done by the dealer, the air/fuel reading changed richer or leaner because the season changed, the customer took the vehicle and unit back to the dealer to have it reset.

While driving in the mountains, where the atmospheric pressure is low, the air/fuel ratio was reading leaner, the customer avoided doing full throttle runs.

3. Operation Method:

Sensor Break-in Procedure

After installation is complete you must break-in the sensor by doing the following. If you do not brake-in the sensor you may not be able to make the needle stable.

- Warm-up the engine and sensor thoroughly, by idling.
- Make full throttle run (5-6x) for 10 minutes.

Try to raise the O₂ sensor to 700° C (1290° F)

To create high exhaust press. make the runs in 4th or 5th gear.

- After you break-in the sensor, check to see that the needle reads toward the richer side of 14.6 A/F when you are full throttle in 4th or 5th gear.

- After you break-in the sensor, check to see when you down shift, as an engine brake, the needle reads toward the leaner side of 14.6 A/F

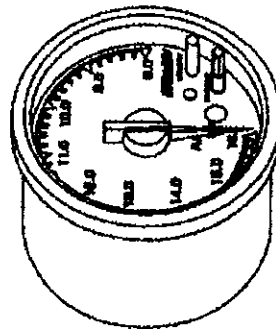
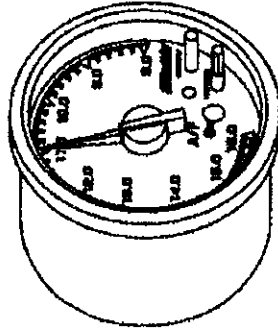

Important !

In order to break-in the sensor, you must run the car at very high speeds. This is very dangerous! Therefore you should only proceed on a engine dyno or a closed track. If the break-in is not complete the needle may not be stable.

3. Operation Method:

Please read and understand the following notes about this product thoroughly.

Warning !

While driving, do not operate the unit's switch, volume, and /or data link . Driving while not paying full attention to the road, may cause a serious accident

(1) Gauge Diagram

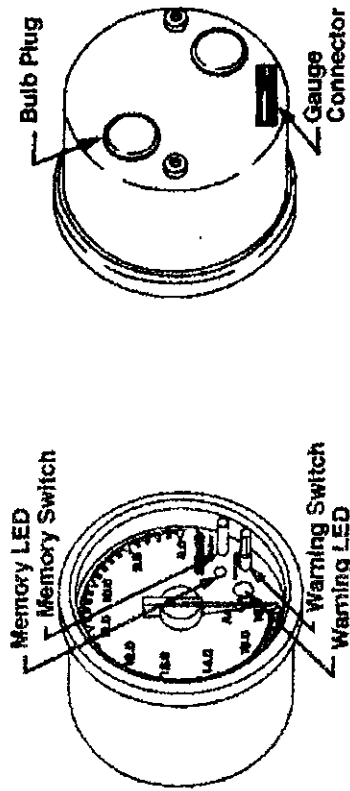

Memory Switch:

Used to changes between "Hold Mode" to "Peak Mode"

Memory LED:

Indicates when in "Warm Up Mode," "Overheat Mode," or "Peak Mod."

Warning Switch:

Used to change into Warning Setting Mode
Used to change the Warning Point Value

Warning LED:

Indicates when in "Warm Up Mode," "Overheat Mode," "Warning Mode," or "Short Circuit."
Illuminates when in "Warning Mode"

3. Operation Method:

Warm-Up Mode

With the needle location and LED flashing pattern, you can monitor the warm up procedure.

When cold, the "Connection Failure Check Function" will activate.

As the O2 sensor warms up the unit will return to normal operation. (this is not a system error)

- Warm Up [0 - 50%]

The needle will point to 15.0 A/F
The Memory LED and Warning LED will blink simultaneously.



- Warm Up [50 - 80%]

The needle will point to 13.0 A/F

The Memory LED and Warning LED will blink simultaneously.



- Warm Up [80 - 100%]

The gauge will begin to display the current A/F ratio.

The Memory LED and Warning LED will blink simultaneously.

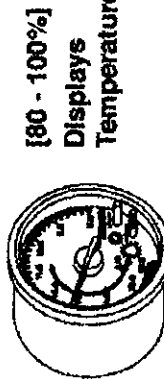

- [100%]

Operating Temperature



Important !

Even if the engine is fully warmed up and the the EGT is above 500° C, if the O2 sensor is not fully warmed up the needle movement may be unstable.